

BTA24

Discrete Triacs(Isolated)

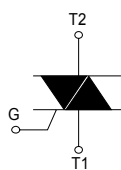

Dimensions TO-220AB

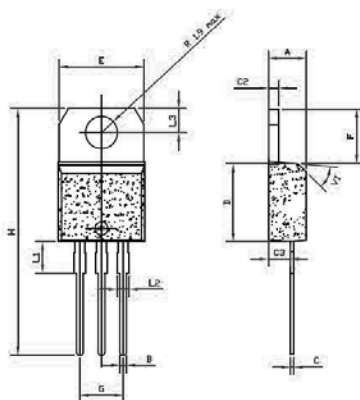

Ref.	Dimensions					
	Millimeters			Inches		
	Min.	Typ.	Max.	Min.	Typ.	Max.
A	4.4		4.6	0.173		1.181
B	0.61		0.88	0.024		0.034
C	0.46		0.70	0.018		0.027
C2	1.23		1.32	0.048		0.051
C3	2.4		2.72	0.094		0.107
D	8.6		9.7	0.338		0.382
E	9.8		10.4	0.386		0.409
F	6.2		6.6	0.244		0.259
G	4.8		5.4	0.189		0.213
H	28.0		29.8	11.0		11.7
L1		3.75			0.147	
L2	1.14		1.7	0.044		0.066
L3	2.65		2.95	0.104		0.116
V1		40°			40°	

V_{DRM}/V_{RRM} V_{DSM}/V_{RSM}
V V

BTA24-200	200	300
BTA24-400	400	500
BTA24-600	600	700
BTA24-800	800	900
BTA24-1000	1000	1100
BTA24-1200	1200	1300

ABSOLUTE MAXIMUM RATINGS

Symbol	Parameter	Value	Unit
$I_{T(RMS)}$	RMS on-state current (full sine wave) TO-220AB $T_c = 100^\circ\text{C}$	24	A
I_{TSM}	Non repetitive surge peak on-state current (full cycle, T_j initial = 25°C)	F = 60 Hz $t = 16.7$ ms	250
		F = 50 Hz $t = 20$ ms	260
I^2t	I^2t Value for fusing $t_p = 10$ ms	340	A^2s
di/dt	Critical rate of rise of on-state current $I_G = 2 \times I_{GT}$, $t_r \leq 100$ ns F = 120 Hz $T_j = 125^\circ\text{C}$	50	$\text{A}/\mu\text{s}$
V_{DSM}/V_{RSM}	Non repetitive surge peak off-state voltage $t_p = 10$ ms $T_j = 25^\circ\text{C}$	$V_{DRM}/V_{RRM} + 100$	V
I_{GM}	Peak gate current $t_p = 20$ μs $T_j = 125^\circ\text{C}$	4	A
$P_{G(AV)}$	Average gate power dissipation $T_j = 125^\circ\text{C}$	1	W
T_{stg} T_j	Storage junction temperature range Operating junction temperature range	- 40 to + 150 - 40 to + 125	$^\circ\text{C}$

ELECTRICAL CHARACTERISTICS ($T_j = 25^\circ\text{C}$, unless otherwise specified)

■ SNUBBERLESS and LOGIC LEVEL(3 Quadrants)

Symbol	Test Conditions	Quadrant	BTA&		Unit	
			CW	BW		
$I_{GT}(1)$	$V_D = 12$ V $R_L = 33$ Ω	I - II - III	MAX.	35	50	mA
V_{GT}		I - II - III	MAX.	1.3		V
V_{GD}	$V_D = V_{DRM}$ $R_L = 3.3$ k Ω $T_j = 125^\circ\text{C}$	I - II - III	MIN.	0.2		V
$I_H(2)$	$I_T = 500$ mA		MAX.	50	75	mA
I_L	$I_G = 1.2$ I_{GT}	I - III	MAX.	70	80	mA
		II		80	100	
$dV/dt(2)$	$V_D = 67\%$ V_{DRM} gate open $T_j = 125^\circ\text{C}$		MIN.	500	1000	$\text{V}/\mu\text{s}$
$(di/dt)_c(2)$	Without snubber $T_j = 125^\circ\text{C}$		MIN.	13	22	A/ms

BTA24

Discrete Triacs(Isolated)

■ STANDARD (4 Quadrants)

Symbol	Test Conditions	Quadrant		Value	Unit
I_{GT} (1)	$V_D = 12\text{ V}$ $R_L = 33\ \Omega$	I - II - III IV	MAX.	50 100	mA
V_{GT}		ALL	MAX.	1.3	V
V_{GD}	$V_D = V_{DRM}$ $R_L = 3.3\ \Omega$ $T_j = 125^\circ\text{C}$	ALL	MIN.	0.2	V
I_H (2)	$I_T = 500\text{ mA}$		MAX.	80	mA
I_L	$I_G = 1.2 I_{GT}$	I - III - IV	MAX.	70	mA
		II		160	
dV/dt (2)	$V_D = 67\% V_{DRM}$ gate open $T_j = 125^\circ\text{C}$		MIN.	500	V/ μs
$(dV/dt)_c$ (2)	$(dI/dt)_c = 13.3\text{ A/ms}$ $T_j = 125^\circ\text{C}$		MIN.	10	V/ μs

STATIC CHARACTERISTICS

Symbol	Test Conditions		Value	Unit	
V_{TM} (2)	$I_{TM} = 24\text{ A}$ $t_p = 380\ \mu\text{s}$	$T_j = 25^\circ\text{C}$	MAX.	1.55	V
V_{to} (2)	Threshold voltage	$T_j = 125^\circ\text{C}$	MAX.	0.85	V
R_d (2)	Dynamic resistance	$T_j = 125^\circ\text{C}$	MAX.	16	m Ω
I_{DRM}	$V_{DRM} = V_{RRM}$	$T_j = 25^\circ\text{C}$	MAX.	5	μA
I_{RRM}		$T_j = 125^\circ\text{C}$		3	mA

Note 1: minimum IGT is guaranteed at 5% of IGT max.

Note 2: for both polarities of A2 referenced to A1

THERMAL RESISTANCES

Symbol	Parameter	Value	Unit
$R_{th(j-c)}$	Junction to case (AC)	0.8	$^\circ\text{C/W}$
$R_{th(j-a)}$	Junction to ambient	60	$^\circ\text{C/W}$

PRODUCT SELECTOR

Part Number	Voltage (xxx)		Sensitivity	Type	Package
	200 V	~ 1200 V			
BTA24	X	X	50 mA	Standard	TO-220AB

OTHER INFORMATION

Part Number	Marking	Weight	Base quantity	Packing mode
BTA24	BTA24	2 g	250	Bulk

BTA24

Discrete Triacs(Isolated)

Fig. 1 : Maximum power dissipation versus RMS on-state current (full cycle).

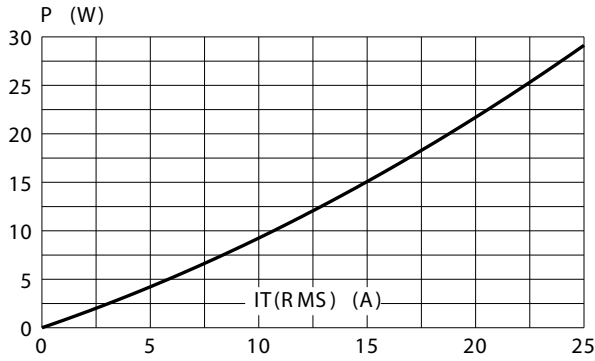

Fig. - 2 : RMS on-state current versus case temperature (full cycle).

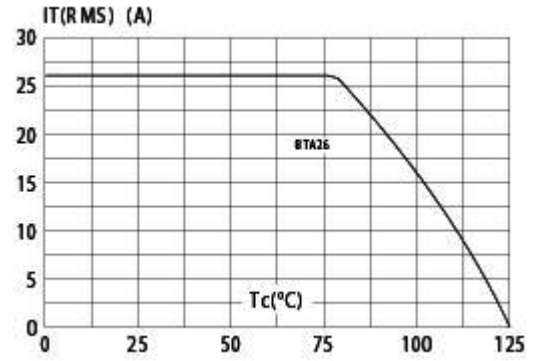

Fig. 3 : Relative variation of thermal impedance versus pulse duration.

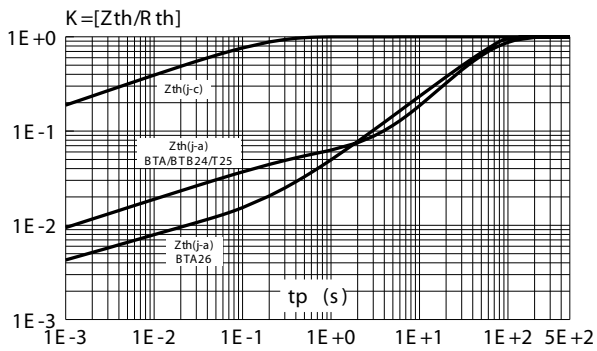

Fig. 4 : On-state characteristics (maximum values).

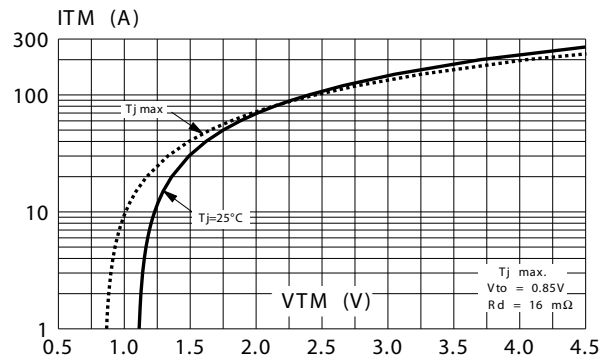
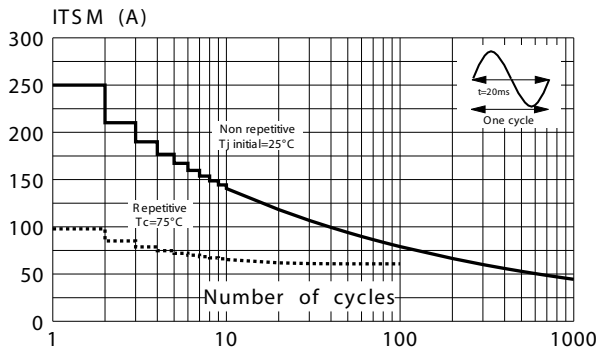

Fig. 5 : Surge peak on-state current versus number of cycles.



BTA24

Discrete Triacs(Isolated)

Fig. 6: Non-repetitive surge peak on-state current for a sinusoidal pulse with width $t_p < 10\text{ms}$, and corresponding value of I^2t .

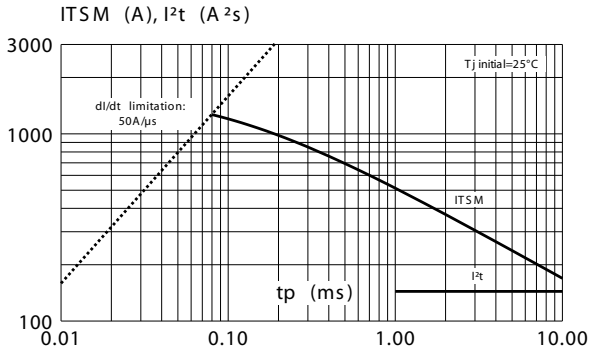

Fig.8 : Relative variation of critical rate of decrease of main current versus $(dV/dt)_c$ (typical values).

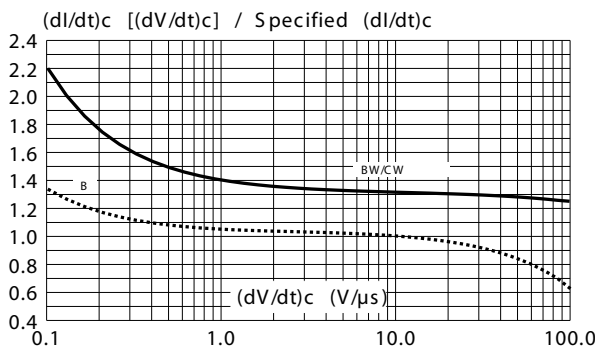

Fig. 7: Relative variation of gate trigger current, holding current and latching current versus junction temperature (typical values).

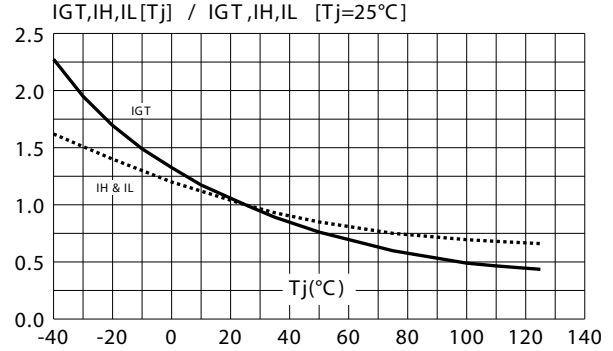

Fig. 9 : Relative variation of critical rate of decrease of main current versus junction temperature.

