

**N-CHANNEL 12 x 8 CROSSPOINT SWITCH  
WITH CONTROL MEMORY**

- LOW ON RESISTANCE (typ. 35Ω at V<sub>DD</sub> = 14V)
- INTERNAL CONTROL LATCHES
- 2 V<sub>PP</sub> ANALOG SIGNAL CAPABILITY
- LESS THAN 1% TOTAL DISTORTION AT 0dBm
- LESS THAN - 95dB CROSS-TALK AT 1KHZ  
1 V<sub>PP</sub>

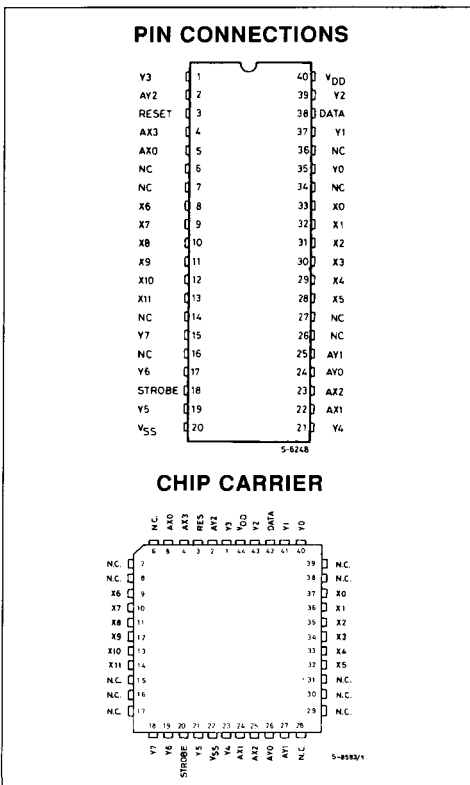
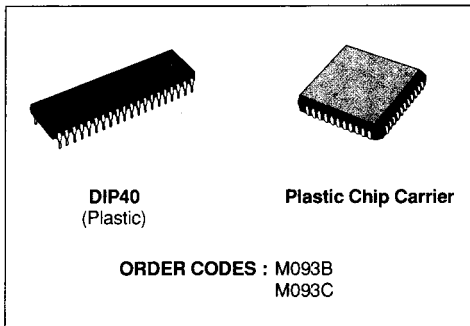

**DESCRIPTION**

The M093 contains a 12 x 8 array of cross-point together with a 7 to 96 line decoder and latch circuits. Anyone of the 96 switches can be addressed by selecting the appropriate 7 input bits. The selected switch can be turned on or off by applying a logical one or zero to the data in and the strobe input at logical one. A reset signal can be used to turn off all the switches together when is switched at logical one.

The M093 is available in a 40 lead dual in-line plastic or 44 lead plastic chip carrier packages. Logic inputs are TTL compatible.

**BLOCK DIAGRAM**

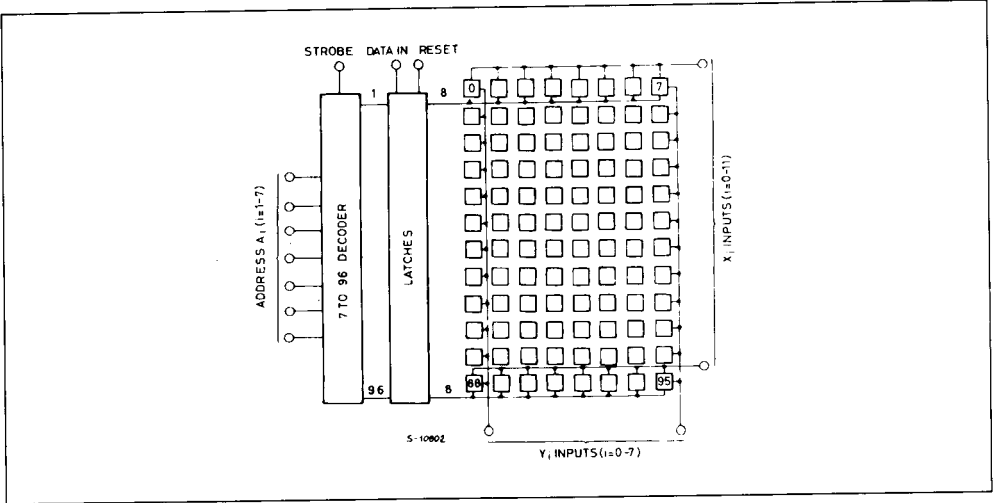

**ABSOLUTE MAXIMUM RATINGS**

Symbol	Parameter	Value	Unit
V <sub>DD</sub>	DC Supply Voltage	- 0.5 to 18	V
V <sub>IN</sub>	Input Voltage Range	- 0.5 to V <sub>DD</sub> + 0.5	V
I <sub>IN</sub>	DC Input Current (analog input)	± 10	mA
P <sub>tot</sub>	Power Dissipation	1	W
T <sub>op</sub>	Operating Temperature Range	0 to 70	°C
T <sub>stg</sub>	Storage Temperature Range	- 50 to 125	°C

Stresses in excess of those listed under "Absolute Maximum Ratings" may cause permanent damage to the device. This is a stress rating only and functional operation of the device at these or any other conditions in excess of those indicated in the operational sections of this specification is not implied. Exposure to absolute maximum rating conditions for extended periods may affect device reliability.

## THRU TABLE

Address							Connections
AX0	AX1	AX2	AX3	AY0	AY1	AY2	
0	0	0	0	0	0	0	X0 - Y0
1	0	0	0	0	0	0	X1 - Y0
0	1	0	0	0	0	0	X2 - Y0
1	1	0	0	0	0	0	X3 - Y0
0	0	1	0	0	0	0	X4 - Y0
1	0	1	0	0	0	0	X5 - Y0
0	1	1	0	0	0	0	No Connection
1	1	1	0	0	0	0	No Connection
0	0	0	1	0	0	0	X6 - Y0
1	0	0	1	0	0	0	X7 - Y0
0	1	0	1	0	0	0	X8 - Y0
1	1	0	1	0	0	0	X9 - Y0
0	0	1	1	0	0	0	X10 - Y0
1	0	1	1	0	0	0	X11 - Y0
0	1	1	1	0	0	0	No Connection
1	1	1	1	0	0	0	No Connection
0	0	0	0	1	0	0	X0 - Y1
↓	↓	↓	↓	↓	↓	↓	↓
1	0	1	1	1	0	0	X11 - Y1
0	0	0	0	0	1	0	X0 - Y2
↓	↓	↓	↓	↓	↓	↓	↓
1	0	1	1	0	1	0	X11 - Y2
0	0	0	0	1	1	0	X0 - Y3
↓	↓	↓	↓	↓	↓	↓	↓
1	0	1	1	1	1	0	X11 - Y3
0	0	0	0	0	0	1	X0 - Y4
↓	↓	↓	↓	↓	↓	↓	↓
1	0	1	1	0	0	1	X11 - Y4
0	0	0	0	1	0	1	X0 - Y5
↓	↓	↓	↓	↓	↓	↓	↓
1	0	1	1	1	0	1	X11 - Y5
0	0	0	0	0	1	1	X0 - Y6
↓	↓	↓	↓	↓	↓	↓	↓
1	0	1	1	0	1	1	X11 - Y6
0	0	0	0	1	1	1	X0 - Y7
↓	↓	↓	↓	↓	↓	↓	↓
1	0	1	1	1	1	1	X11 - Y7

## RECOMMENDED OPERATING CONDITION

Symbol	Parameter	Value	Unit
V <sub>DD</sub>	Supply Voltage	10 to 16	V
T <sub>OP</sub>	Operating Temperature	0 to 70	°C
V <sub>IN</sub>	(logic signal)	0 to V <sub>DD</sub>	

**STATIC ELECTRICAL CHARACTERISTICS** ( $T_{amb} = 0$  to  $70^{\circ}\text{C}$ ,  $V_{DD} = 14\text{V}$ )

## CROSSPOINT

Symbol	Parameter	Test Conditions	Min.	Typ.	Max.	Unit
	Operating Current	$f_o = 100\text{KHz}$			35	mA
	On Resistance	$V_{IDC} = 6.75\text{V}$ $V_{ODC} = 6.5\text{V}$ (see fig. 1)		35	60	$\Omega$
	$\Delta R$ on between any 2 Switch			6	10	$\Omega$
	Off Leakage*	All Switches off $V_{OS} = V_{IS} = 0$ to $V_{DD}$			$\pm 3$	$\mu\text{A}$

## CONTROLS

Symbol	Parameter	Test Conditions	Min.	Typ.	Max.	Unit
$V_{IL}$					0.8	V
$V_{IN}$			2.4			V
	Input Leakage*	$V_{IN} = 0$ to $V_{DD}$			$\pm 3$	$\mu\text{A}$

\* These limits are valid on the total temperature range :  $0-70^{\circ}\text{C}$  at  $25^{\circ}\text{C}$  these limits become  $\pm 100\text{nA}$ .

**DYNAMIC ELECTRICAL CHARACTERISTICS** ( $T_{amb} = 25^{\circ}\text{C}$ ,  $C_L = 50\text{pF}$  all input square wave rise and fall times =  $20\text{ns}$ ,  $V_{DD} = 14\text{V}$ )

## CROSSPOINTS

Symbol	Parameter	Test Conditions					Value			Unit
		Note	$f_i$ (KHz)	$R_L$ (K $\Omega$ )	$V_{IS}$ ( $V_{PP}$ )	$V_{DC}$ (V)	Min.	Typ.	Max.	
$t_{PHL}, t_{PLH}$	Propagation Delay Time (switch ON) Signal Input to Output	Fig. 2		1	2	5		30	100	ns
	Frequency Response (any switch ON) ( $20 \log (V_{OS}/V_{IS}) = -3\text{dB}$ )	$C_L = 3\text{pF}$		0.091	2	5		50		MHz
	Sine Wave Distortion		1000	0.091	2	5			1	%
	Feedthrough (all switches OFF)	Fig. 3	10	1	2	5	-90			dB
	Frequency for Signal Crosstalk Attenuation of 40dB Attenuation of 110dB	Fig. 4		1	2	5	1			MHz
							5			KHz
C	Capacitance Xn to Ground							15		pF
	Yn to Ground		1000		0.1	5		15		
	Feedthrough							0.4		
C	Capacitance Logic Input to Ground		1000		0.1	5		5		pF

## DYNAMIC ELECTRICAL CHARACTERISTICS (continued)

## CONTROLS

Symbol	Parameter	Test Conditions			Value			Unit
			See Fig.	V <sub>DD</sub> (V)	Min.	Typ.	Max.	
t <sub>PSN</sub>	Propagation Delay Time Strobe to Output (switch turn-ON)	R <sub>L</sub> = 1KΩ t <sub>r</sub> , t <sub>f</sub> = 20ns C <sub>L</sub> = 50pF	5	14V			400	ns
t <sub>PZH</sub>	Data-in to Output (turn-ON to high level)		6	14V			500	ns
t <sub>PAN</sub>	Address to Output (turn-ON to high level)		7	14V			400	ns
t <sub>PSF</sub>	Propagation Delay Time Strobe to Output (switch turn-OFF)		5	14V			300	ns
t <sub>PZL</sub>	Data-in to Output (turn-ON to low level)		6	14V			500	ns
t <sub>PAF</sub>	Address to Output (turn-OFF)		7	14V			300	ns
t <sub>SS</sub>	Set-up Time Data-in to Strobe		5	14V	120			ns
t <sub>SH</sub>	Hold Time Data-in to Strobe		5	14V	200			ns
t <sub>AS</sub>	Set-up Time Data-in to Address		7	14V	160			ns
t <sub>AH</sub>	Hold Time Data-in to Address		7	14V	100			ns
f <sub>O</sub>	Switching Frequency			14V		1		MHz
t <sub>w</sub>	Strobe Pulse Width			14V	100			ns
	Control Crosstalk Data-in, Address, or Strobe to Output		Square Wave Input t <sub>r</sub> , t <sub>f</sub> = 20ns V <sub>IN</sub> = 3V R <sub>L</sub> = 10KΩ	8	14V		75	
t <sub>w</sub>	Reset Pulse Width	R <sub>L</sub> = 1KΩ t <sub>r</sub> , t <sub>f</sub> = 20ns C <sub>L</sub> = 50pF	9	14V	100			ns
t <sub>PHZ</sub>	Reset Turn-OFF Delay		9	14V			260	ns

TEST CIRCUITS

Figure 1 : R<sub>ON</sub> Measurement.

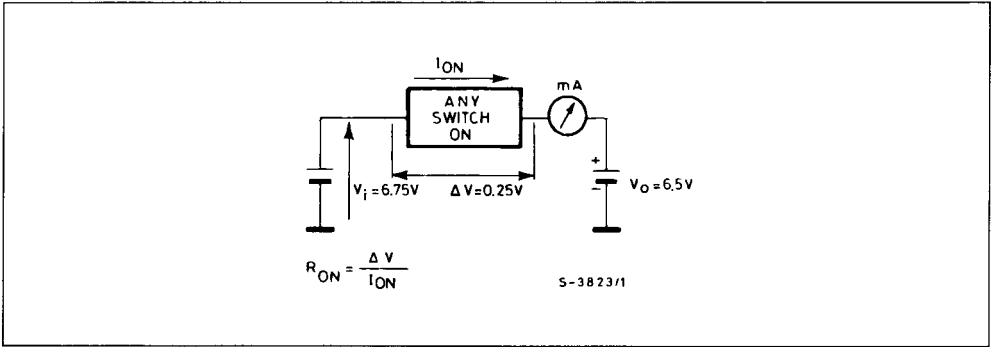

Figure 2 : Propagation Delay Time and Waveforms (signal input to signal output, switch ON).

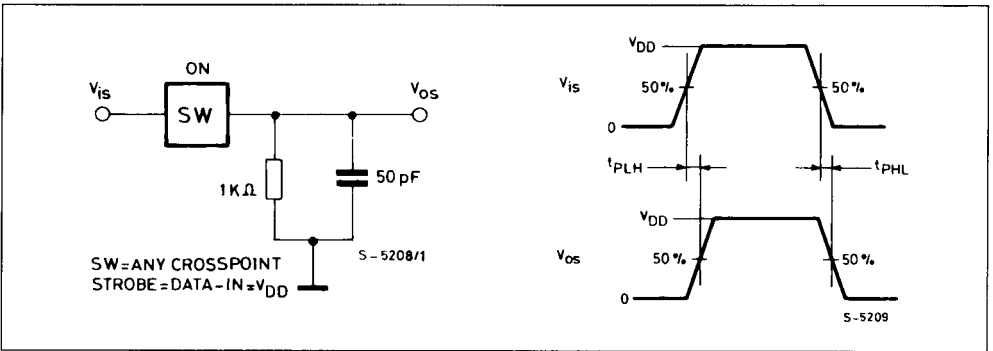
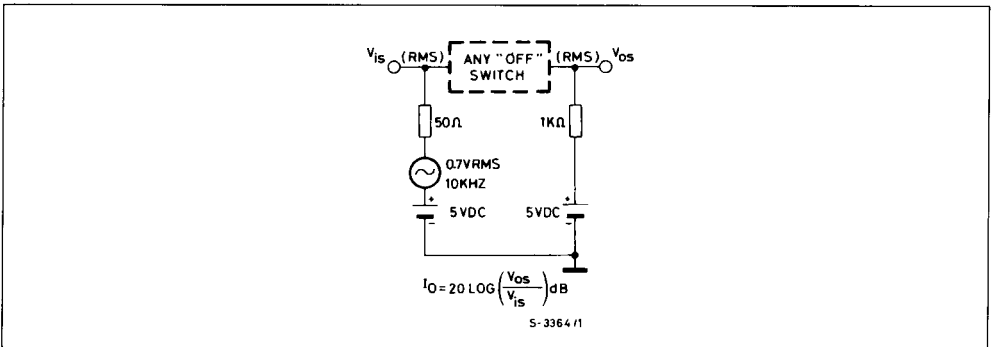

Figure 3 : Off Isolation Measurement (Feed through).



TEST CIRCUITS (continued)

Figure 4 : Crosstalk Measurements.

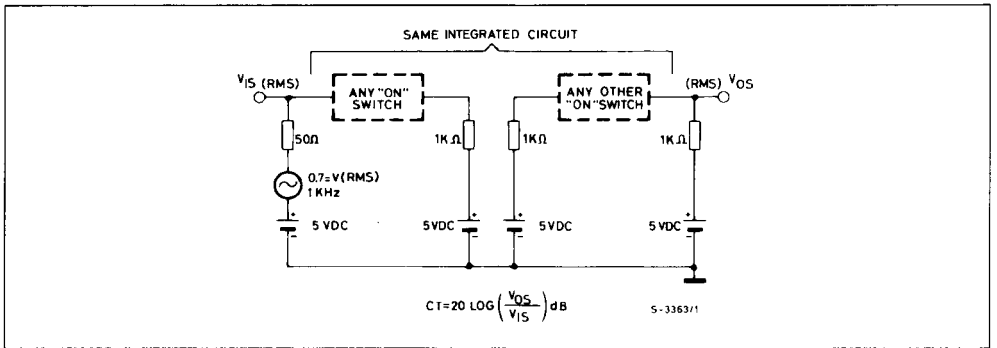

Figure 5 : Propagation Delay Time and Waveforms (strobe to signal output, switch Turn-ON or Turn-OFF).

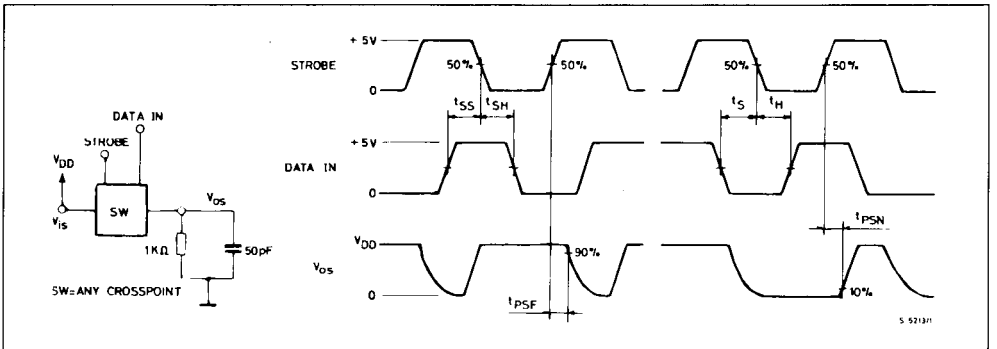
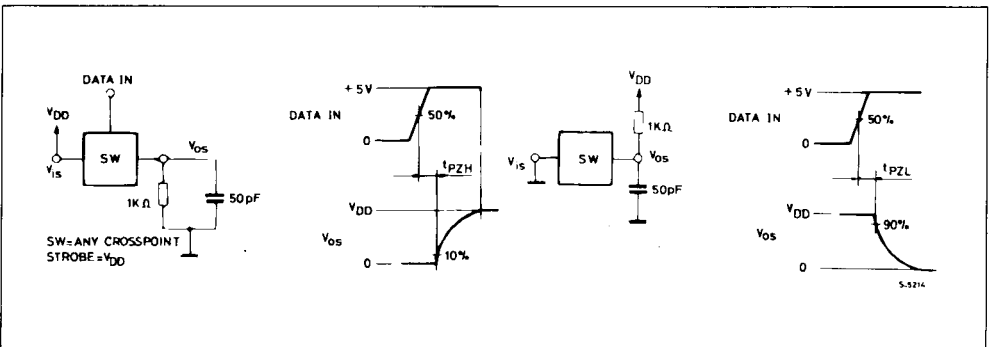

Figure 6 : Propagation Delay Time and Waveforms (data-in signal output, switch Turn-ON to high or low level).



TEST CIRCUITS (continued)

Figure 7 : Propagation Delay Time and Waveforms (address to signal output, switch Turn-ON or Turn-OFF).

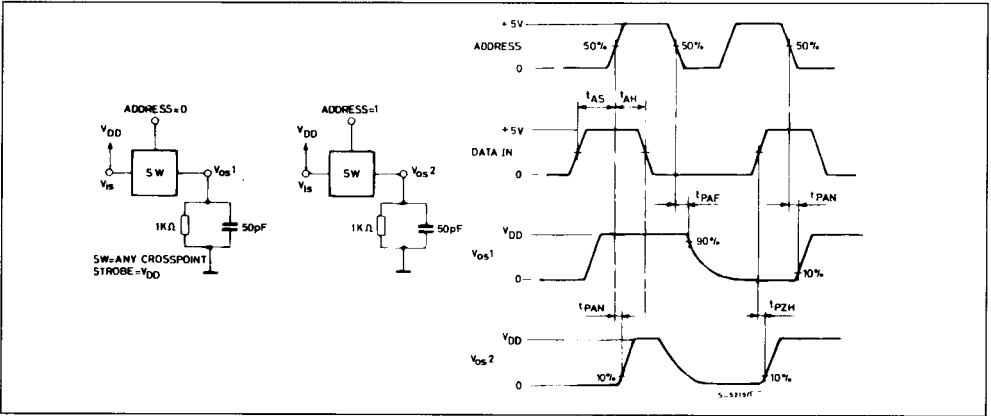

Figure 8 : Waveforms for Crosstalk (control input to signal output).

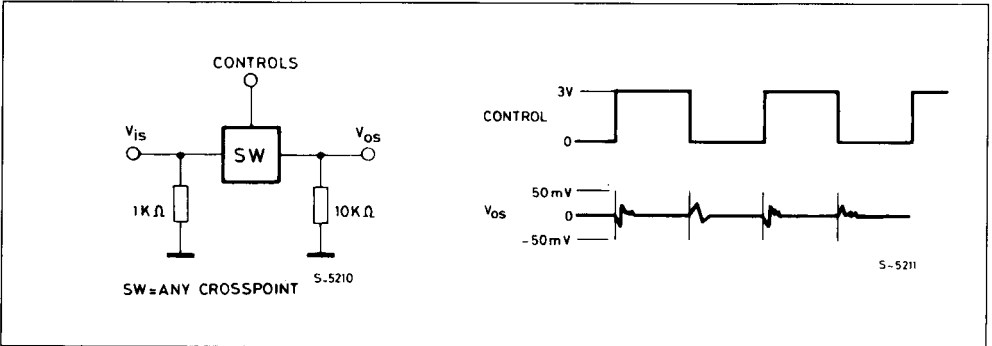
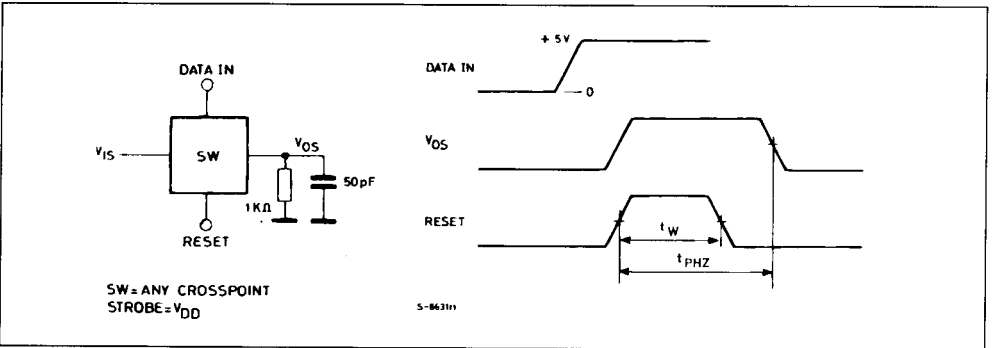

Figure 9 : Propagation Delay Time and Waveforms (reset to output delay).



Note : Data latch can be performed either by the strobe falling edge or by the address change (with strobe at high level). Advised operation is to move data/address with strobe input at 0, then latching with a strobe pulse.



www.DataSheet4U.com

Typical ON Resistance vs.  $V_{DD}$ .

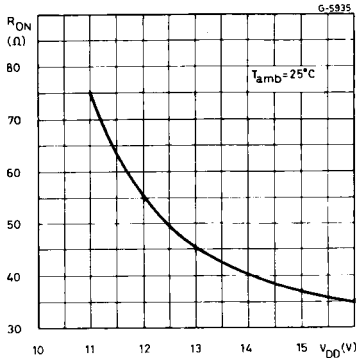

Typical ON Resistance vs.  $V_{DD}$ .

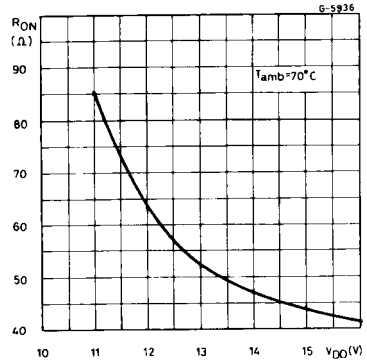

Typical Crosstalk between two CROSS-POINT vs. Input Frequency.

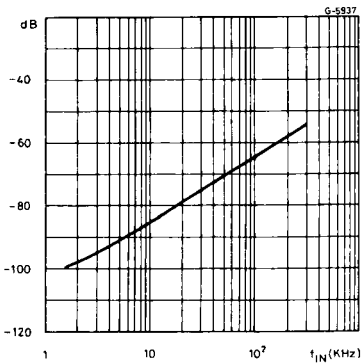

Typical ON Resistance vs. Temperature.

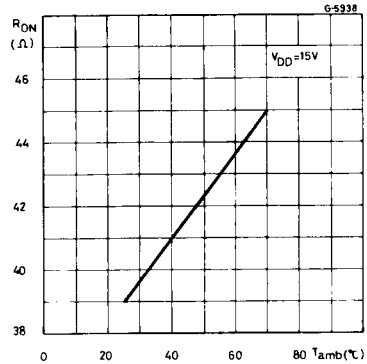

Typical Maximum  $I_{DD}$  vs.  $V_{DD}$ .

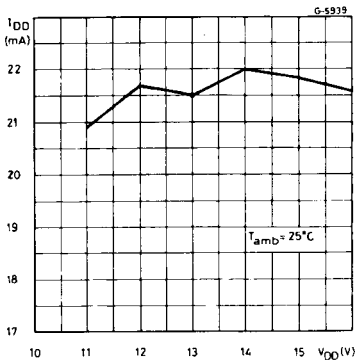

Typical Maximum  $I_{DD}$  vs.  $V_{DD}$ .

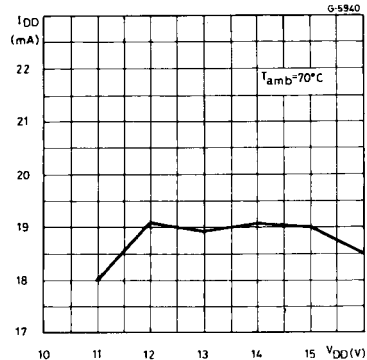

Typical Maximum I<sub>DD</sub> vs. Temperature.

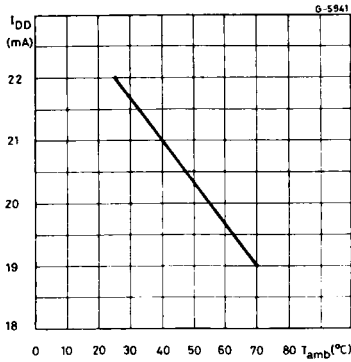

Bandwidth Insertion Loss vs. Frequency.

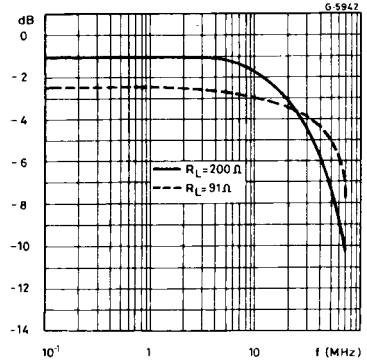

Typical Crosstalk Switches vs. Signal Frequency.

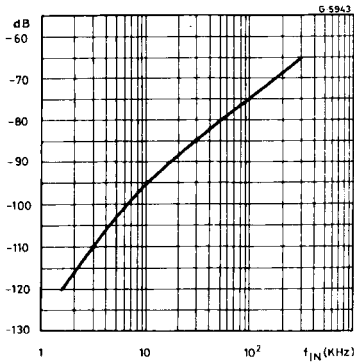

Crosstalk vs. Power Supply at Every Switch.

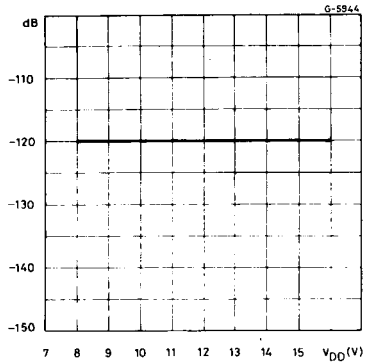

Pin Dependence V<sub>IH</sub> and V<sub>IL</sub>.

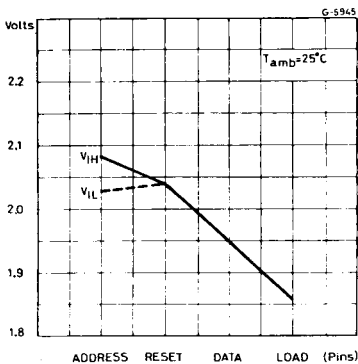

Pin Dependence V<sub>IH</sub> and V<sub>IL</sub>.

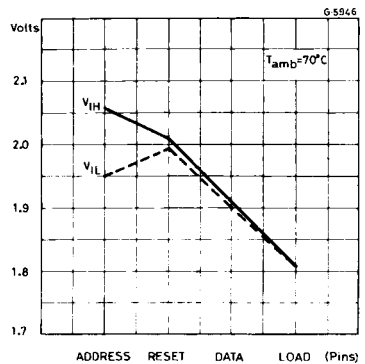

Typical  $V_{IL}$  and  $V_{IH}$  vs. Temperature.

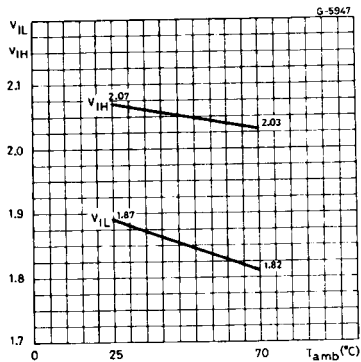

Typical  $V_{IL}$  vs.  $V_{DD}$ .

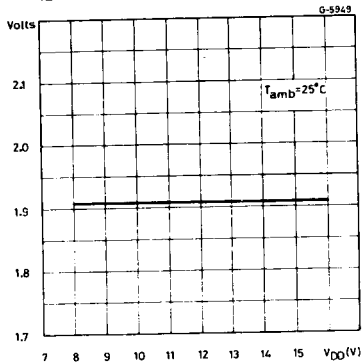

Typical  $V_{IL}$  vs.  $V_{DD}$ .

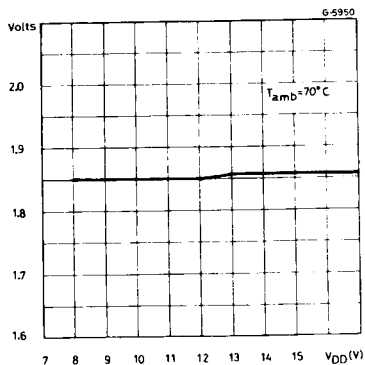

Typical  $V_{IH}$  vs.  $V_{DD}$ .

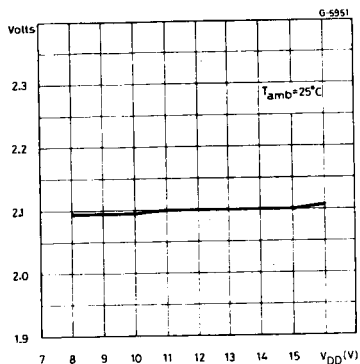

Typical  $V_{IH}$  vs.  $V_{DD}$ .

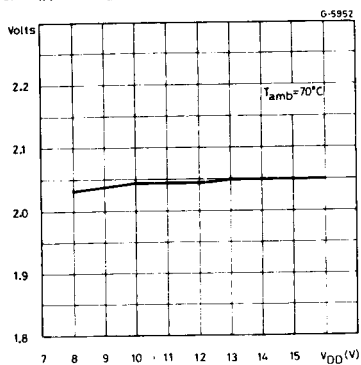

SO-8J

SO-14J

T-90-20

S G S-THOMSON

www.DataSheet4U.com

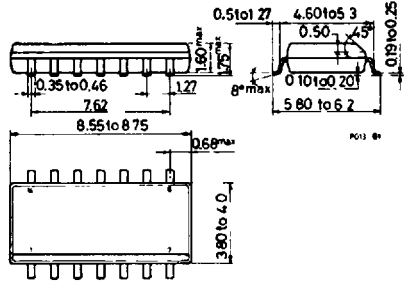
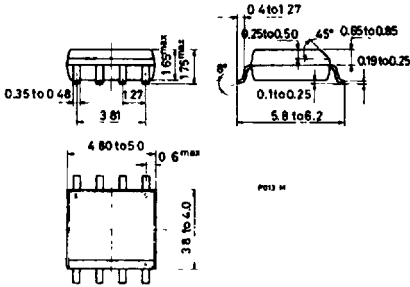
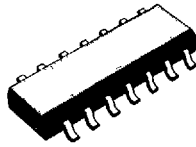
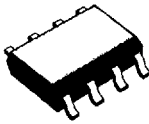

PLCC20

PLCC44

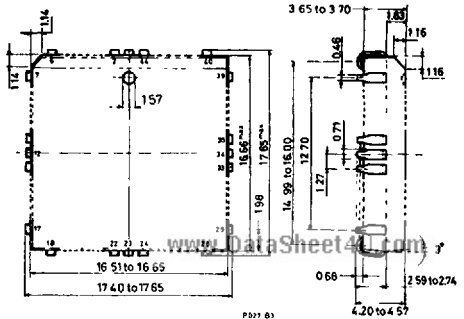
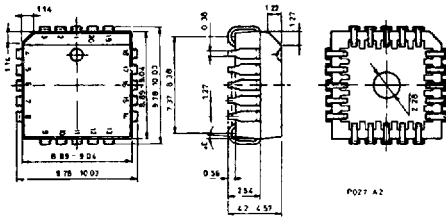
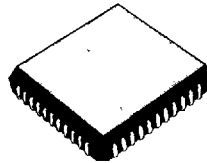
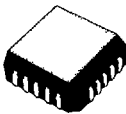

www.DataSheet4U.com

# PLCC-28 Plastic Chip Carrier

www.DataSheet4U.com

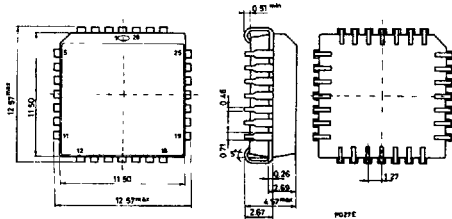
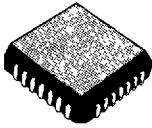

# DIP-6

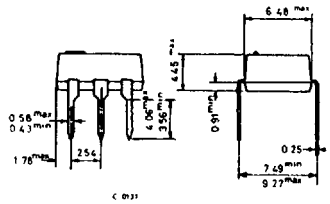
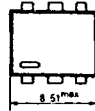

# Minidip A Plastic

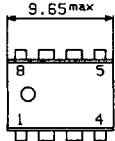
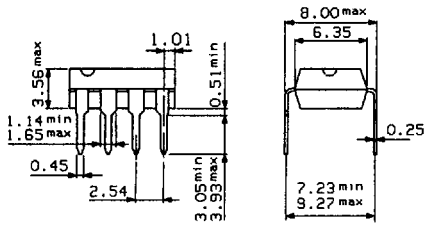
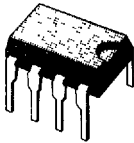

C-0140

# 8 lead Plastic Minidip

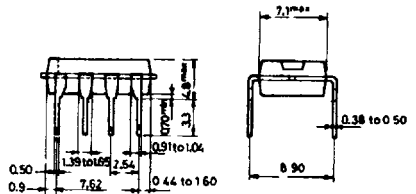
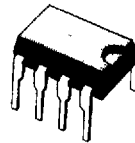

P001-F6

www.DataSheet4U.com

### 14 lead Ceramic Dip

www.DataSheet4U.com

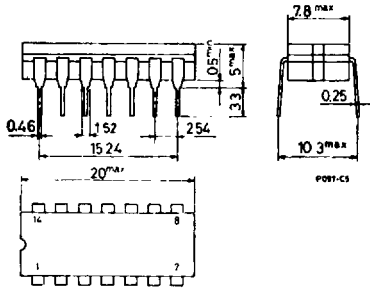
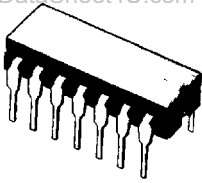

POD1-C3

### 14 lead Plastic Dip

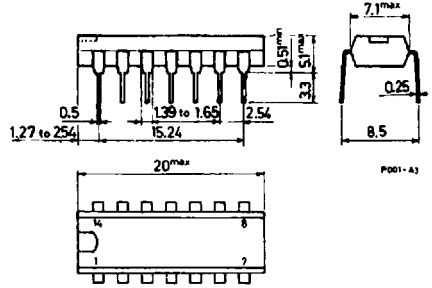
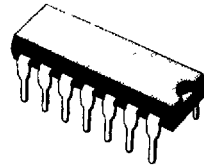

POD1-A3

### 16 lead Ceramic Dip

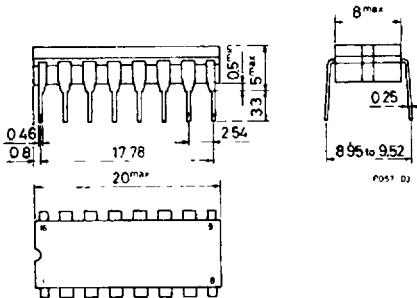
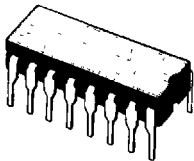

POD1-D2

### 16 lead Plastic Dip (0.25)

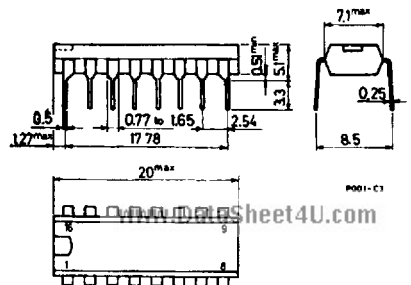
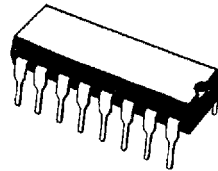

POD1-C1

www.DataSheet4U.com

### DIP-20 Ceramic

www.DataSheet4U.com

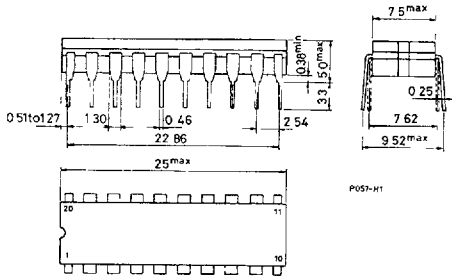
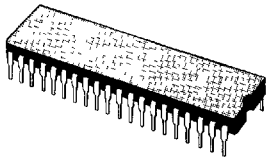

### 20 lead Plastic Dip (0.25)

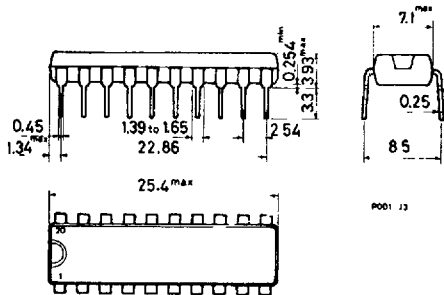
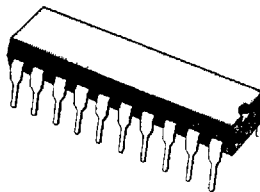

### DIP-24 Plastic

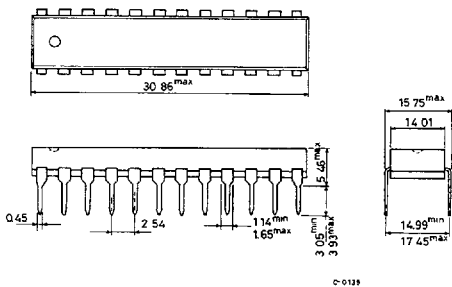
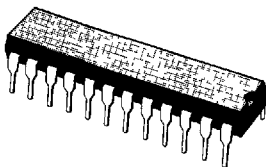

### DIP-24 Ceramic (0.25)

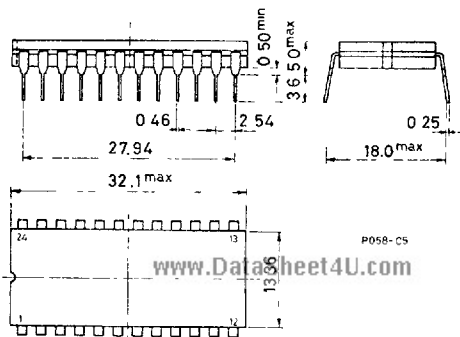
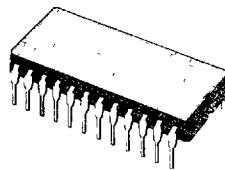

www.DataSheet4U.com

## 28 lead Plastic Dip

www.DataSheet4U.com

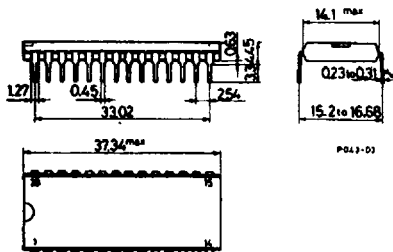
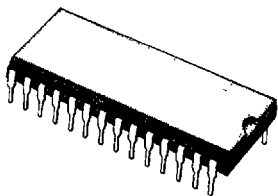

## DIP-28 Ceramic (0.25)

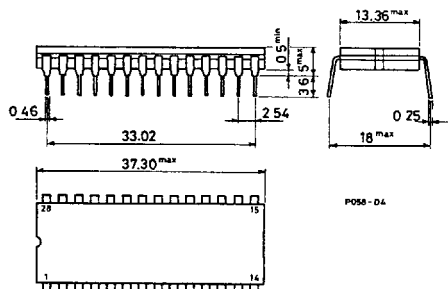
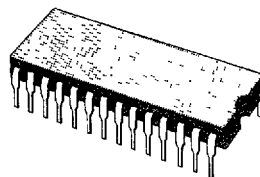

## 40 lead Plastic Dip

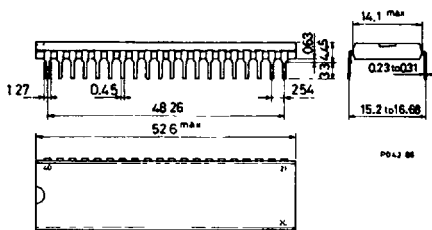
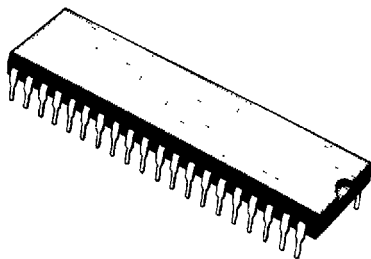

## TO-99

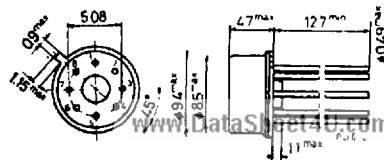
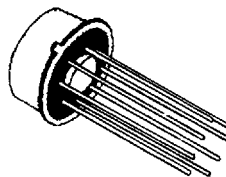



# MULTIWATT-15

www.DataSheet4U.com

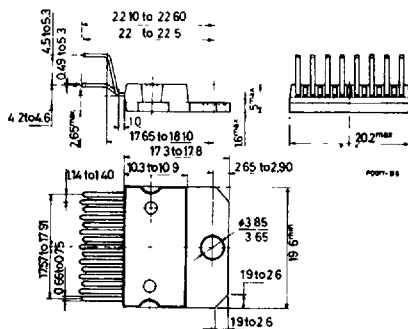
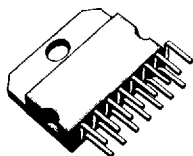

# FLEXIWATT-15

