

BT136-600

4 Quadrants Sensitive TRIAC

FEATURES

- ❑ Repetitive Peak Off-State Voltage : 600V
- ❑ R.M.S On-State Current ($I_{T(RMS)} = 4A$)
- ❑ Sensitive Gate Trigger Current
 - 5[mA] of IGT at I, II and III Quadrants.
 - 12[mA] of IGT at IV Quadrant.

Applications

Heating control, Lighting control, Motor control such like dimmer, sensor light, Humidifier, etc.

General Description

Semihow's sensitive TRIAC product is a glass passivated device, has a low gate trigger current, high stability in gate trigger current to variation of operating temperature and high off state voltage. It is generally suitable for power and phase control in ac application.

Absolute Maximum Ratings ($T_J=25^\circ\text{C}$ unless otherwise specified)

$V_{DRM} = 600\text{ V}$
$I_{T(RMS)} = 4\text{ A}$
$I_{TSM} = 33\text{ A}$
$I_{GT} = 5\text{mA}/12\text{mA}$

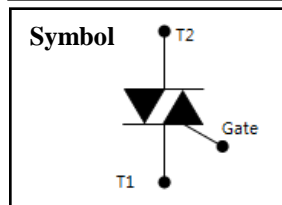

Symbol	Parameter	Conditions	Ratings	Unit
V_{DRM}	Repetitive Peak Off-State Voltage	Sine wave, 50/60Hz, Gate open	600	V
V_{RRM}	Repetitive Peak Reverse Voltage		600	V
$I_{T(AV)}$	Average On-State Current	Full sine wave, $T_C = 109.5^\circ\text{C}$	3.6	A
$I_{T(RMS)}$	R.M.S. On-State Current		4	A
I_{TSM}	Surge On-State Current	½ cycle, 50Hz/60Hz, Sine wave, Non repetitive	30/33	A
I^2t	Fusing Current	$t = 10\text{ms}$	4.5	A ² S
P_{GM}	Forward Peak Gate Power Dissipation	$T_J = 125^\circ\text{C}$	2	W
$P_{G(AV)}$	Forward Average Gate Power Dissipation	$T_J = 125^\circ\text{C}$, over any 20ms	0.2	W
I_{FGM}	Forward Peak Gate Current	$T_J = 125^\circ\text{C}$, pulse width $\leq 20\mu\text{s}$	1	A
V_{RGM}	Reverse Peak Gate Voltage	$T_J = 125^\circ\text{C}$, pulse width $\leq 20\mu\text{s}$	6	V
T_J	Operating Junction Temperature		-40~+125	$^\circ\text{C}$
T_{STG}	Storage Temperature		-40~+150	$^\circ\text{C}$

Electrical Characteristics ($T_J=25^\circ\text{C}$ unless otherwise specified)

Symbol	Parameter	Conditions	Min	Typ	Max	Unit	
I_{DRM}	Repetitive Peak Off-State Current	$V_D = V_{\text{DRM}}$	$T_J=25^\circ\text{C}$	-	-	50	μA
			$T_J=125^\circ\text{C}$	-	-	5	mA
I_{RRM}	Repetitive Peak Reverse Current	$V_D = V_{\text{DRM}}$	$T_J=25^\circ\text{C}$	-	-	50	μA
			$T_J=125^\circ\text{C}$	-	-	5	mA
I_{GT}	Gate Trigger Current	$V_D = 12\text{V}, R_L=330\Omega$	1+, 1-, 3-	-	-	5	mA
			3+	-	-	12	mA
V_{GT}	Gate Trigger Voltage	$V_D = 12\text{V}, R_L=330\Omega$	1+, 1-, 3-	-	-	1.5	V
			3+	-	-	2.0	V
V_{GD}	Non-Trigger Gate Voltage ¹	$V_D = 12\text{V}, R_L=330\Omega, T_J=125^\circ\text{C}$	0.2	-	-	V	
V_{TM}	Peak On-State Voltage	$I_T = 5.6\text{A}, I_G = 20\text{mA}$	-	-	1.6	V	
dv/dt	Critical Rate of Rise of Off-State Voltage	$V_D = 2/3 V_{\text{DRM}}, T_J=125^\circ\text{C}$	10	-	-	V/us	
I_{H}	Holding current	$I_T = 0.2\text{A}$	-	5	-	mA	

Notes :

1. Pulse Width $\leq 1.0\text{ms}$, Duty Cycle $\leq 1\%$

Thermal Characteristics

Symbol	Parameter	Conditions	Min	Typ	Max	Unit
$R_{\theta\text{JC}}$	Thermal Resistance	Junction to Case			3.6	$^\circ\text{C/W}$
$R_{\theta\text{JA}}$	Thermal Resistance	Junction to Ambient			80	$^\circ\text{C/W}$

Typical Characteristics

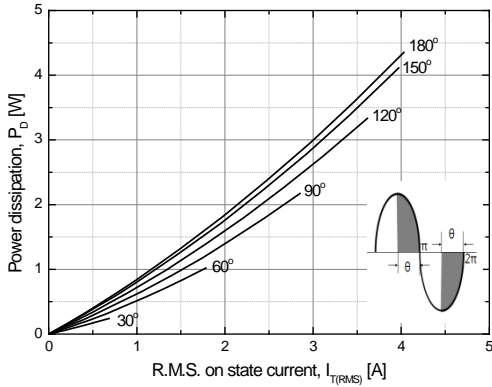

Fig 1. R.M.S. current vs. Power dissipation

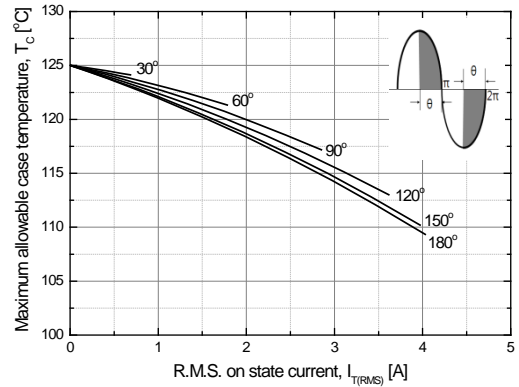

Fig 2. R.M.S. current vs. Case temperature

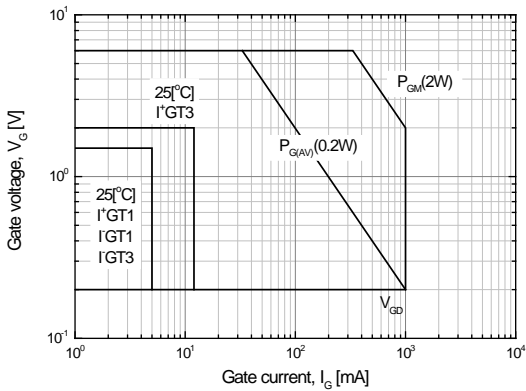

Fig 3. Gate power characteristics

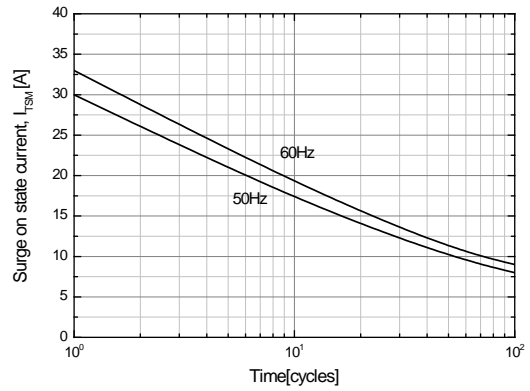

Fig 4. Surge on state current rating (Non-repetitive)

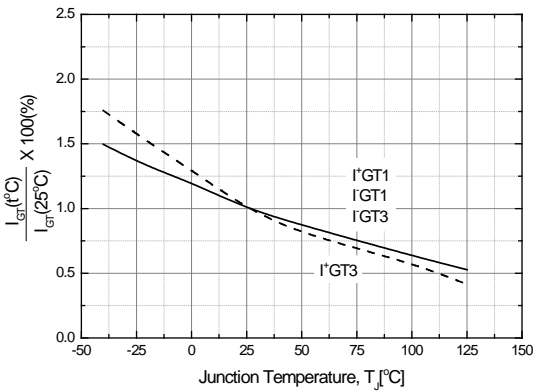

Fig 5. Gate trigger current vs. junction temperature

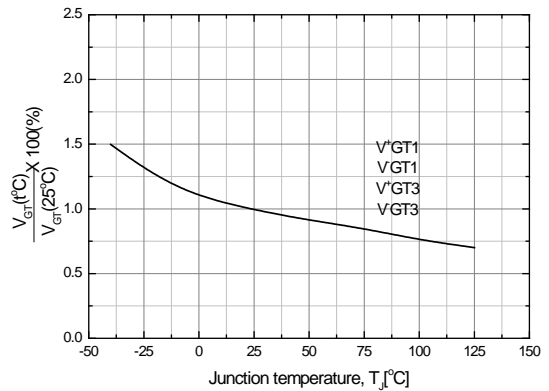

Fig 6. Gate trigger voltage vs. junction temperature

Typical Characteristics

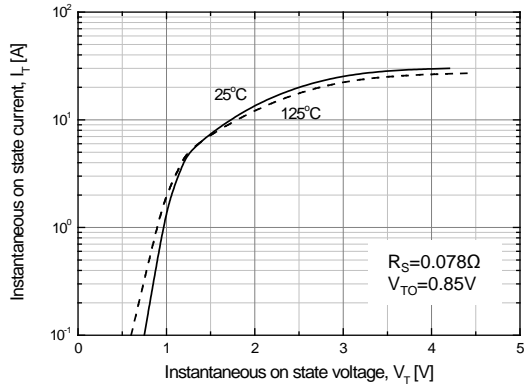

Fig 7. Instantaneous on state current vs. Instantaneous on state voltage

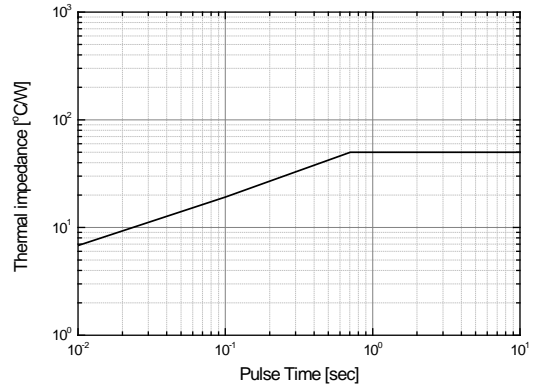
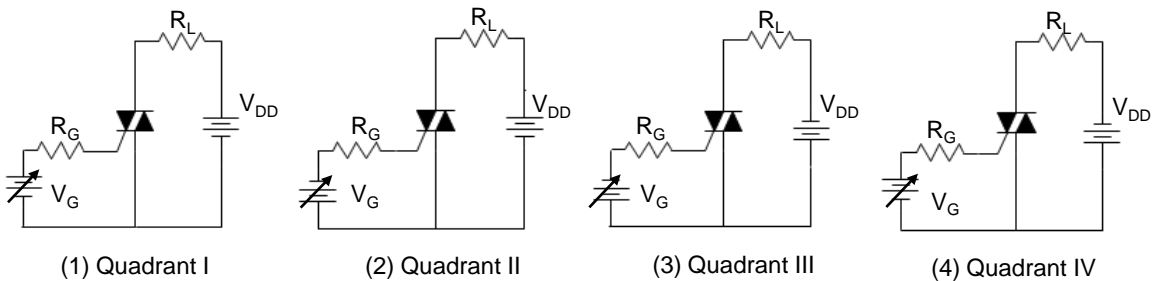

Fig 8. Thermal Impedance vs. pulse time

Measurement of gate trigger current



Note. Whole parameter and test condition can not be over absolute maximum ratings in this datasheet.

Package Dimension

TO-220 (A)

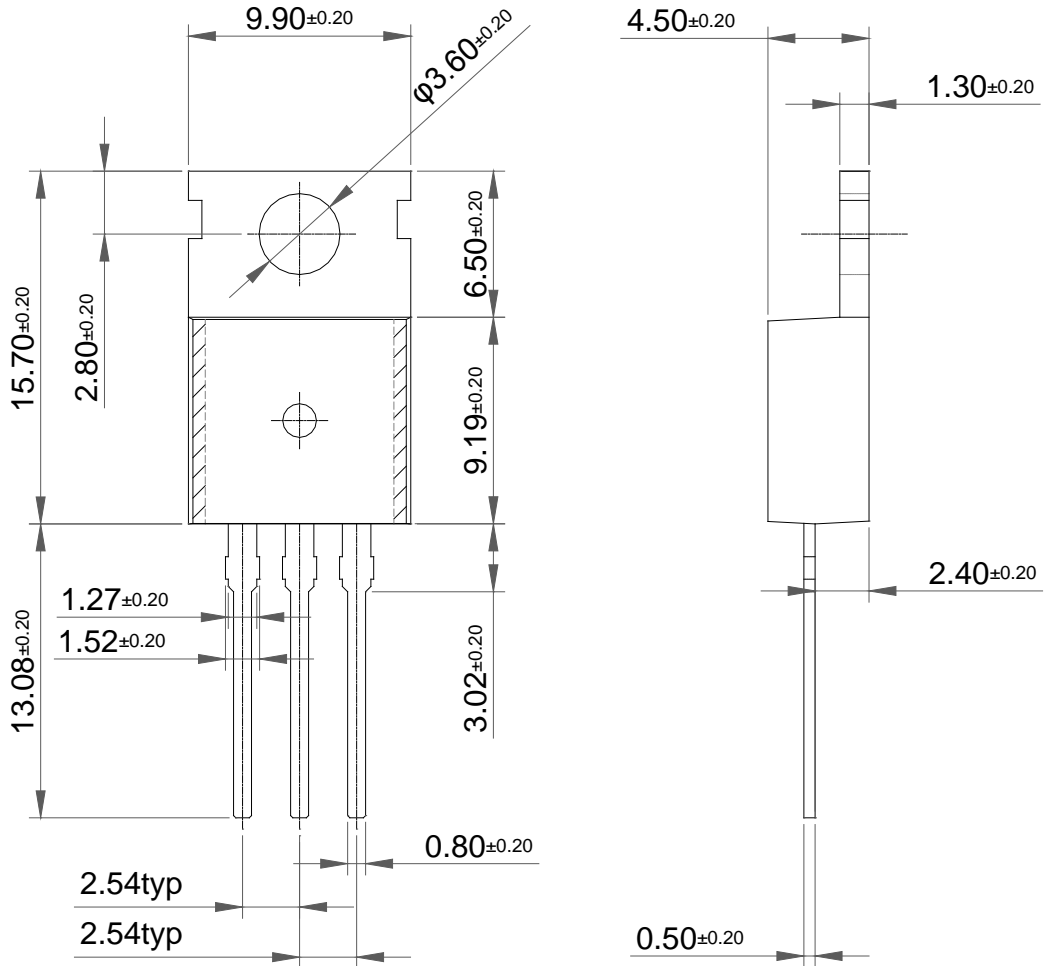

Package Dimension

TO-220 (B)

