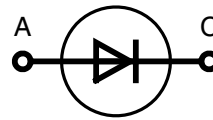
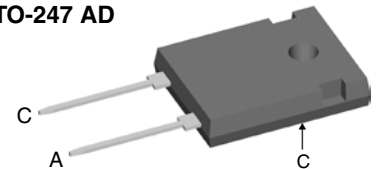

Fast Recovery Epitaxial Diode (FRED)

$I_{FAVM} = 109 \text{ A}$
 $V_{RRM} = 1200 \text{ V}$
 $t_{rr} = 40 \text{ ns}$

V_{RSM}	V_{RRM}	Type
V	V	
1200	1200	DSEI 120-12A

TO-247 AD

A = Anode, C = Cathode

Symbol	Conditions	Maximum Ratings	
I_{FRMS}	$T_{VJ} = T_{VJM}$	100	A
I_{FAVM} ①	$T_C = 60^\circ\text{C}$; rectangular, $d = 0.5$	109	A
I_{FAV} ②	$T_C = 95^\circ\text{C}$; rectangular, $d = 0.5$	75	A
I_{FRM}	$t_p < 10 \mu\text{s}$; rep. rating, pulse width limited by T_{VJM}	1200	A
I_{FSM}	$T_{VJ} = 45^\circ\text{C}$; $t = 10 \text{ ms}$ (50 Hz), sine $t = 8.3 \text{ ms}$ (60 Hz), sine	600	A
		660	A
	$T_{VJ} = 150^\circ\text{C}$; $t = 10 \text{ ms}$ (50 Hz), sine $t = 8.3 \text{ ms}$ (60 Hz), sine	540	A
		600	A
I^2t	$T_{VJ} = 45^\circ\text{C}$; $t = 10 \text{ ms}$ (50 Hz), sine $t = 8.3 \text{ ms}$ (60 Hz), sine	1800	A ² s
		1800	A ² s
	$T_{VJ} = 150^\circ\text{C}$; $t = 10 \text{ ms}$ (50 Hz), sine $t = 8.3 \text{ ms}$ (60 Hz), sine	1450	A ² s
		1500	A ² s
T_{VJ}		-40...+150	°C
T_{VJM}		150	°C
T_{stg}		-40...+150	°C
P_{tot}	$T_C = 25^\circ\text{C}$	357	W
M_d	mounting torque	0.8...1.2	Nm
Weight	typical	6	g

Features

- International standard package JEDEC TO-247 AD
- Planar passivated chips
- Very short recovery time
- Extremely low switching losses
- Low I_{RM} -values
- Soft recovery behaviour
- Epoxy meets UL 94V-0

Applications

- Antiparallel diode for high frequency switching devices
- Anti saturation diode
- Snubber diode
- Free wheeling diode in converters and motor control circuits
- Rectifiers in switch mode power supplies (SMPS)
- Inductive heating and melting
- Uninterruptible power supplies (UPS)
- Ultrasonic cleaners and welders

Advantages

- High reliability circuit operation
- Low voltage peaks for reduced protection circuits
- Low noise switching
- Low losses
- Operating at lower temperature or space saving by reduced cooling

Symbol	Conditions	Characteristic Values		
		typ.	max.	
I_R	$V_R = V_{RRM}$ $T_{VJ} = 25^\circ\text{C}$		3	mA
	$V_R = 0.8 \cdot V_{RRM}$ $T_{VJ} = 25^\circ\text{C}$		1.5	mA
	$V_R = 0.8 \cdot V_{RRM}$ $T_{VJ} = 125^\circ\text{C}$		20	mA
V_F	$I_F = 70 \text{ A}$ $T_{VJ} = 150^\circ\text{C}$ $T_{VJ} = 25^\circ\text{C}$		1.55	V
			1.8	V
V_{T0}	for power-loss calculations only		1.2	V
r_T	$T_{VJ} = T_{VJM}$		4.6	mΩ
R_{thJC}	(version A)	0.25	0.35	K/W
R_{thCH}				K/W
R_{thJA}			35	K/W
t_{rr}	$I_F = 1 \text{ A}$; $-di/dt = 200 \text{ A}/\mu\text{s}$; $V_R = 30 \text{ V}$; $T_{VJ} = 25^\circ\text{C}$	40	60	ns
I_{RM}	$V_R = 350 \text{ V}$; $I_F = 75 \text{ A}$; $-di_F/dt = 200 \text{ A}/\mu\text{s}$ $L \leq 0.05 \mu\text{H}$; $T_{VJ} = 100^\circ\text{C}$	25	30	A

① Chip capability, ② limited to 70 A by leads Data according to IEC 60747

IXYS reserves the right to change limits, test conditions and dimensions.

20121114a

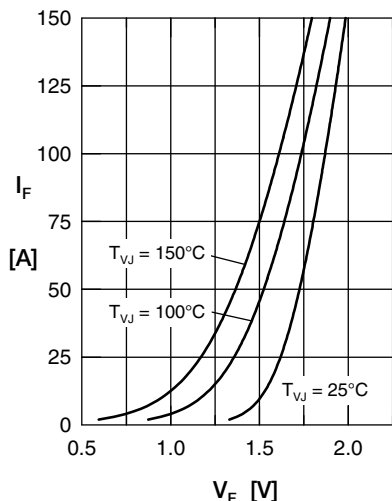

Fig. 1 Forward current I_F vs. V_F

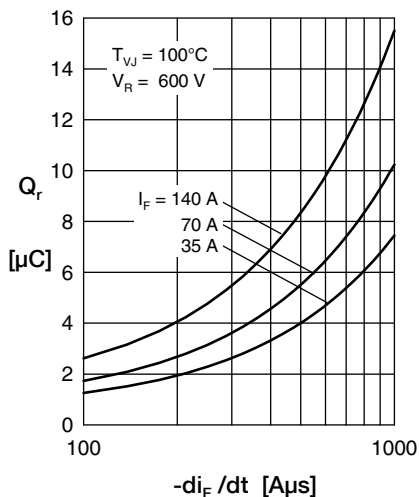

Fig. 2 Reverse recovery charge Q_r versus $-di_F/dt$

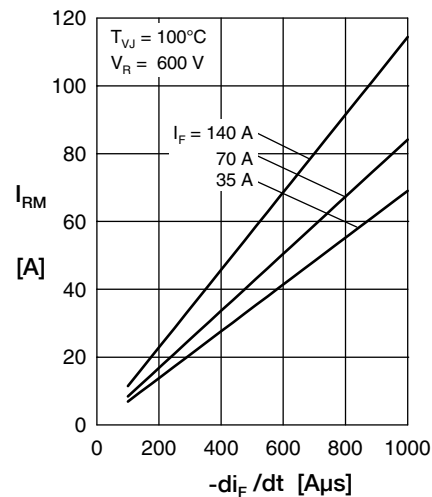

Fig. 3 Peak reverse current I_{RM} versus $-di_F/dt$

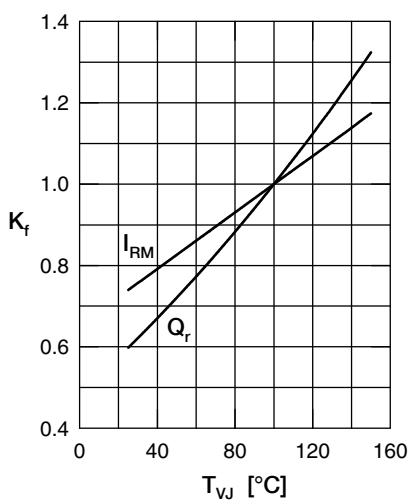

Fig. 4 Dynamic parameters Q_r, I_{RM} versus T_{VJ}

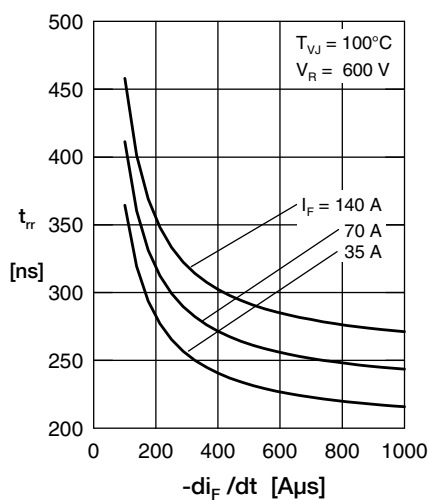

Fig. 5 Recovery time t_{rr} versus $-di_F/dt$

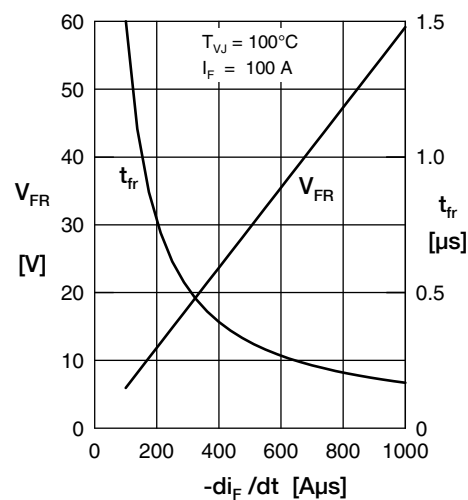

Fig. 6 Peak forward voltage V_{FR} and t_{fr} versus $-di_F/dt$

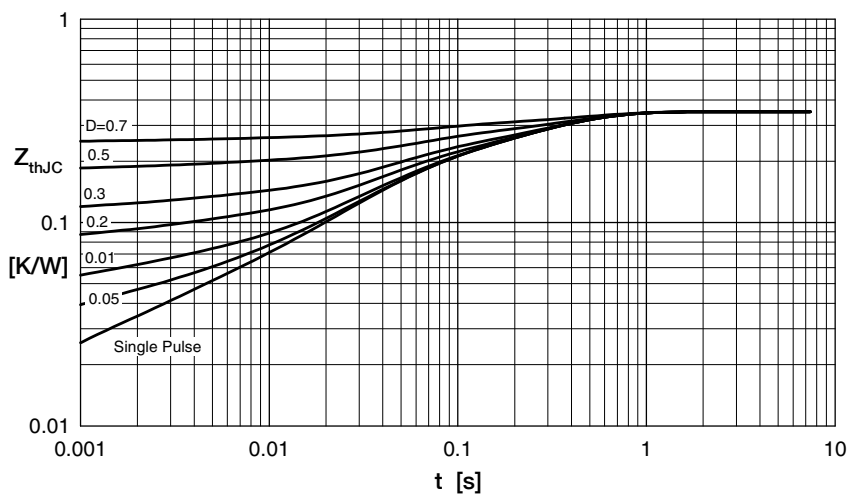
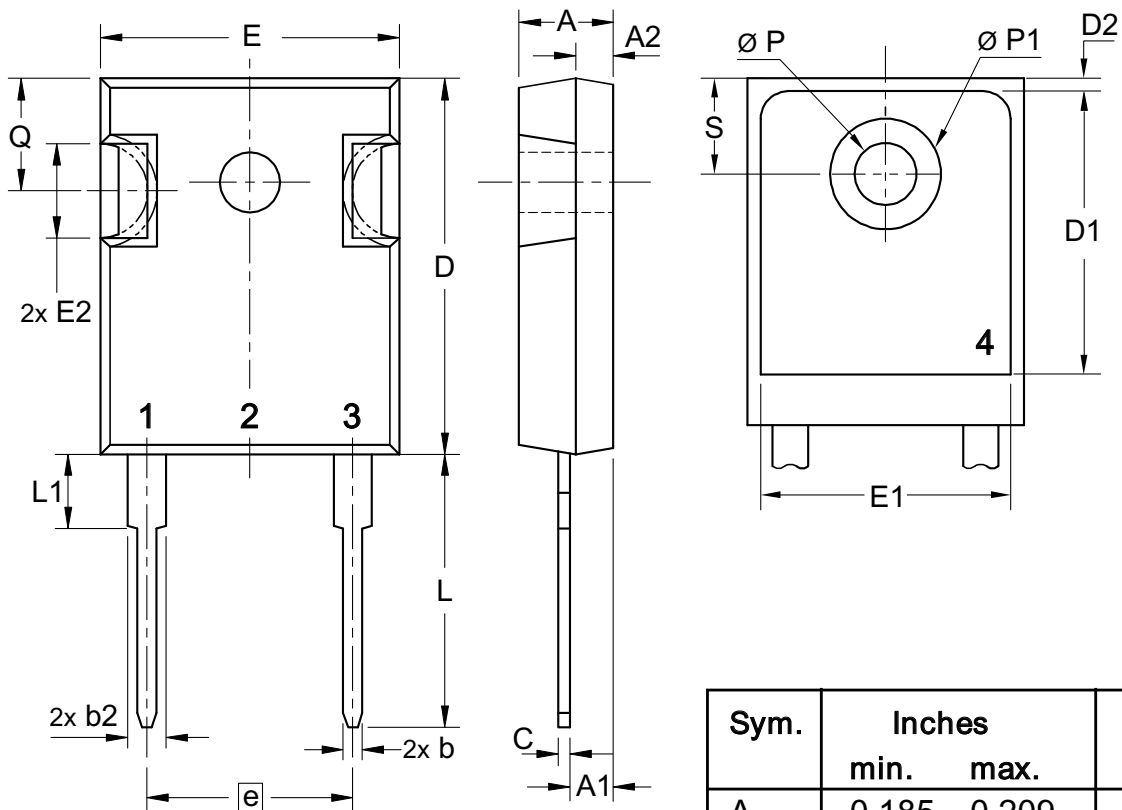

Fig. 7 Transient thermal resistance junction to case at various duty cycles

Constants for Z_{thJC} calculation:

i	R_{thi} (K/W)	t_i (s)
1	0.017	0.00038
2	0.0184	0.0026
3	0.1296	0.0387
4	0.185	0.274

Dimensions TO-247 AD



Sym.	Inches		Millimeter	
	min.	max.	min.	max.
A	0.185	0.209	4.70	5.30
A1	0.087	0.102	2.21	2.59
A2	0.059	0.098	1.50	2.49
D	0.819	0.845	20.79	21.45
E	0.610	0.640	15.48	16.24
E2	0.170	0.216	4.31	5.48
e	0.430 BSC		10.92 BSC	
L	0.780	0.800	19.80	20.30
L1	-	0.177	-	4.49
Ø P	0.140	0.144	3.55	3.65
Q	0.212	0.244	5.38	6.19
S	0.242 BSC		6.14 BSC	
b	0.039	0.055	0.99	1.40
b2	0.065	0.094	1.65	2.39
b4	0.102	0.135	2.59	3.43
c	0.015	0.035	0.38	0.89
D1	0.515	-	13.07	-
D2	0.020	0.053	0.51	1.35
E1	0.530	-	13.45	-
Ø P1	-	0.29	-	7.39