

# Battery Connector

## Features

- RoHS and REACH compliant
- Used to contain cells when inserted into battery compartments
- Battery holder suitable PP3 9V mount



## Specification

Number of Cells	1
Suitable for	9 V Battery
Mounting Type	Snap-On
Connector Connection Method	Soldering

## Cable Specification

Cross-Section AWG	26 AWG
Number of Cores	2
Jacket Material	PVC
Outside Diameter	1.3 x 2.6 mm
Colour	Black / Red

## Material Specification

Wire	Tinned Copper
Contact	Nickel-Plated Copper
Body Material	ABS

## Drawing

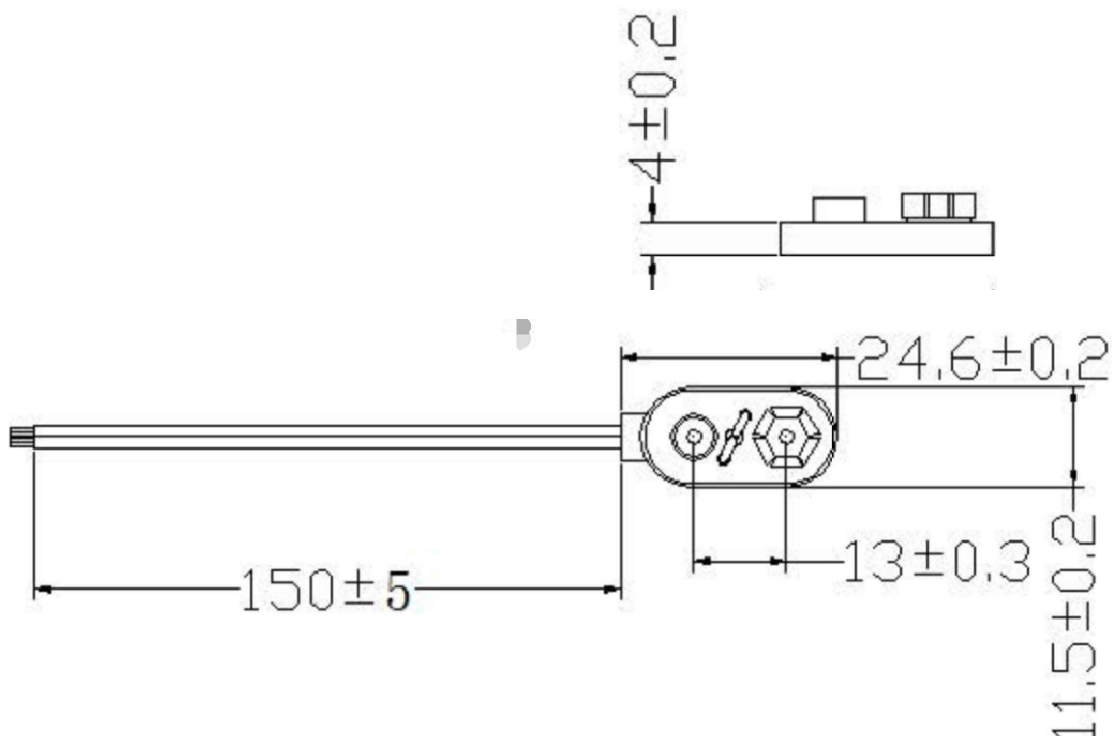

Art Nr.  
RND 305-00042