

Features

- Angle Displacement Measurement
- Bends and Flexes physically with motion device
- Possible Uses
 - Robotics
 - Gaming (Virtual Motion)
 - Medical Devices
 - Computer Peripherals
 - Musical Instruments
 - Physical Therapy
- Simple Construction
- Low Profile

Mechanical Specifications

- Life Cycle: >1 million
- Height: $\leq 0.43\text{mm}$ (0.017")
- Temperature Range: -35°C to $+80^{\circ}\text{C}$

Electrical Specifications

- Flat Resistance: 8K Ohms $\pm 30\%$
- Bend Resistance: minimum 2 times greater than the flat resistance at 180° pinch bend (see "How it Works" below)
- Power Rating : 0.5 Watts continuous; 1 Watt Peak

Dimensional Diagram - Stock Flex Sensor

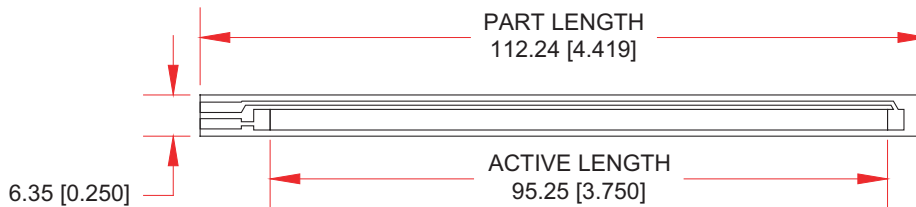

How to Order - Stock Flex Sensor

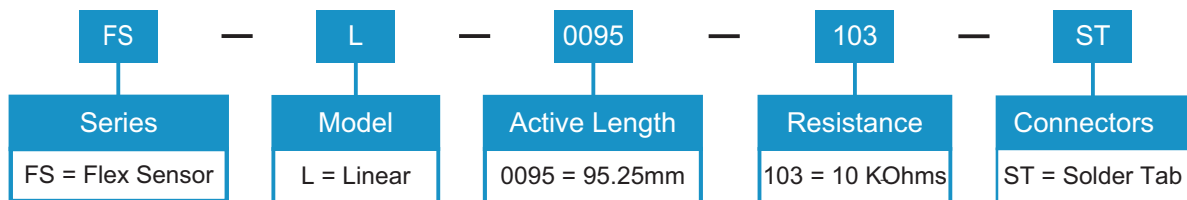

How It Works

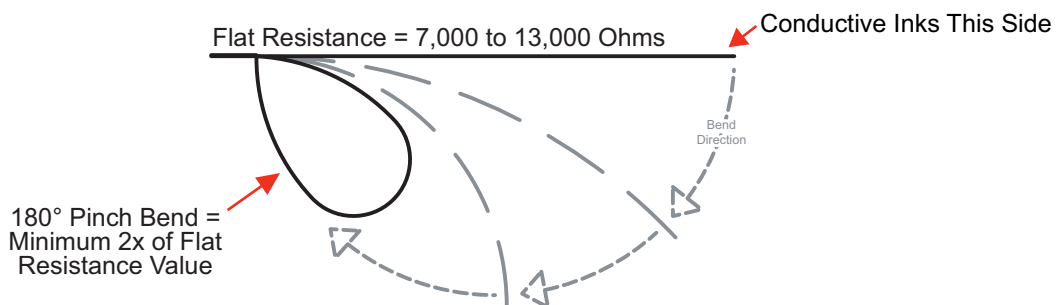

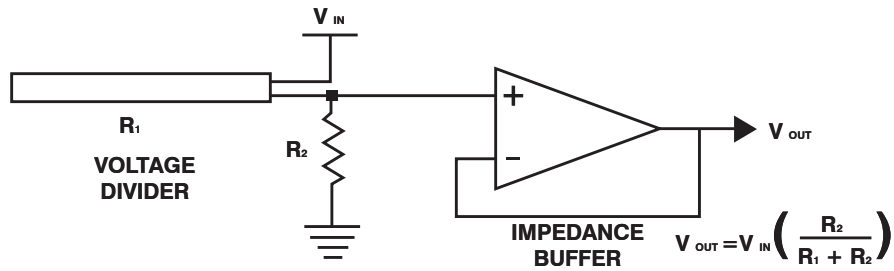

Following are notes from the ITP Flex Sensor Workshop

"The impedance buffer in the [Basic Flex Sensor Circuit] (above) is a single sided operational amplifier, used with these sensors because the low bias current of the op amp reduces error due to source impedance of the flex sensor as voltage divider. Suggested op amps are the LM358 or LM324."

"You can also test your flex sensor using the simplest circuit, and skip the op amp."

"Adjustable Buffer - a potentiometer can be added to the circuit to adjust the sensitivity range."

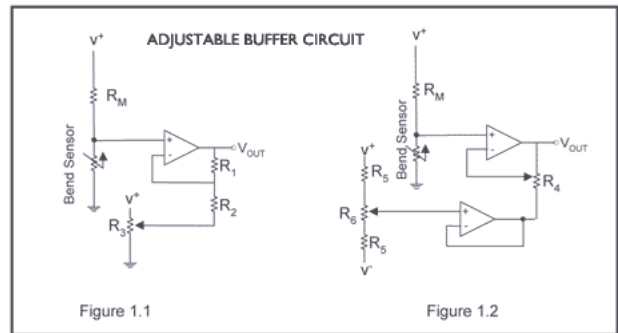

"Variable Deflection Threshold Switch - an op amp is used and outputs either high or low depending on the voltage of the inverting input. In this way you can use the flex sensor as a switch without going through a microcontroller."

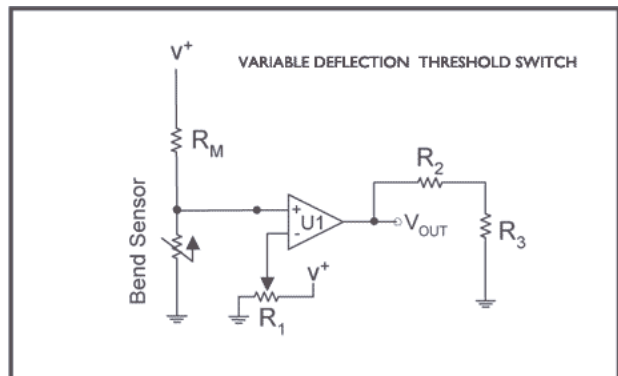

"Resistance to Voltage Converter - use the sensor as the input of a resistance to voltage converter using a dual sided supply op-amp. A negative reference voltage will give a positive output. Should be used in situations when you want output at a low degree of bending."

