

SMD Aluminum Electrolytic Capacitors

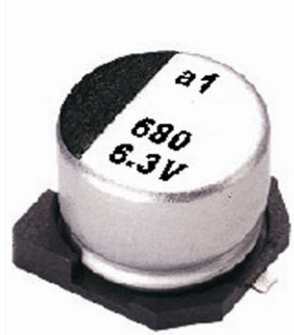

FEATURES

- Polarized aluminum electrolytic capacitors, non-solid electrolyte
- SMD version with base plate, vertical construction, requiring minimum board space
- High CV per unit volume, low impedance, high ripple current
- Ø 4 mm to Ø 18 mm, 105 °C, 2000 h to 5000 h load life
- Material categorization: For definitions of compliance please see www.vishay.com/doc?99912

RoHS
COMPLIANT

APPLICATIONS

- SMD technology, in compliance with RoHS
- Coupling, decoupling, smoothing, filtering, buffering, timing
- General industrial, portable, and lightweight equipment

QUICK REFERENCE DATA

DESCRIPTION	UNIT	VALUE
Nominal case sizes (Ø D x L)	mm	4 x 5.7 to 18 x 21.5
Rated capacitance range	µF	1 to 8200
Capacitance tolerance	%	± 20 (at 120 Hz, 20 °C)
Rated voltage range	V _{DC}	6.3 to 100
Category temperature range:	°C	- 55 to + 105
Endurance	h	2000 to 5000
Shelf life	h	1000

ORDERING INFORMATION

Part number example: ZSC00FE2211HARL

ZSC	00	FE	221	1H	AR	L
SERIES NAME	DESIGN/FORMING	DIMENSIONS	CAPACITANCE	VOLTAGE	PACKING	INTERNAL CODE
		See "Dimensions" table	See "Selection Chart"	See "Selection Chart"	Tape and Reel	

**ADDITIONAL ELECTRICAL DATA**

LEAKAGE CURRENT (Test conditions: U_R , 20 °C)			
RATED VOLTAGE	TIME	CASE SIZE	VALUE
6.3 V to 100 V	after 2 min	Ø 4 mm to Ø 18 mm	$I = 0.01 CV$ or 3 μA , whichever is greater

Notes

- Where, C = Rated capacitance in μF
- V = Rated DC working voltage in V

DISSIPATION FACTOR ($\tan \delta$ at 120 Hz, 20 °C)									
RATED VOLTAGE	6.3	10	16	25	35	50	63	80	100
$\tan \delta$ (max.)	0.30	0.26	0.22	0.16	0.13	0.10	0.08	0.08	0.07

Note

- When the capacitance exceeds 1000 μF , 0.002 shall be added every 1000 μF increase.

LOW TEMPERATURE BEHAVIOR (at 120 Hz)									
IMPEDANCE RATIO	RATED VOLTAGE								
	6.3	10	16	25	35	50	63	80	100
$\frac{Z_{(-25\text{ °C})}}{Z_{(+20\text{ °C})}}$	4	3	2	2	2	2	2	2	2
$\frac{Z_{(-55\text{ °C})}}{Z_{(+20\text{ °C})}}$	8	5	4	3	3	3	3	3	3

MULTIPLIER OF RIPPLE CURRENT AS A FUNCTION OF FREQUENCY	
FREQUENCY (Hz)	CAPACITANCE (μF)
50, 60	0.60
120	0.70
1000	0.85
10 000 and up	1.0

TEST PROCEDURES AND REQUIREMENTS				
TEST	TEST TIME	CAPACITANCE CHANGE	DISSIPATION FACTOR	LEAKAGE CURRENT
Endurance ⁽¹⁾	2000 h	Within $\pm 30\%$ of initial value for $\varnothing \leq D 6.3$ mm and $\varnothing 10 \times 7.7$ L	Less than 300 % of specified value	Within specified value
	5000 h	Within $\pm 30\%$ of initial value for $\varnothing \geq D 8$ mm		
Shelf life ⁽²⁾	1000 h	Within $\pm 30\%$ of initial value		

Notes

- ⁽¹⁾ The specifications shall be satisfied when the capacitors are restored to 20 °C after the rated voltage applied for 2000 h to 5000 h at 105 °C.
- ⁽²⁾ The above specifications shall be satisfied when the capacitors are restored to 20 °C after exposing them for 1000 h at 105 °C without voltage applied.

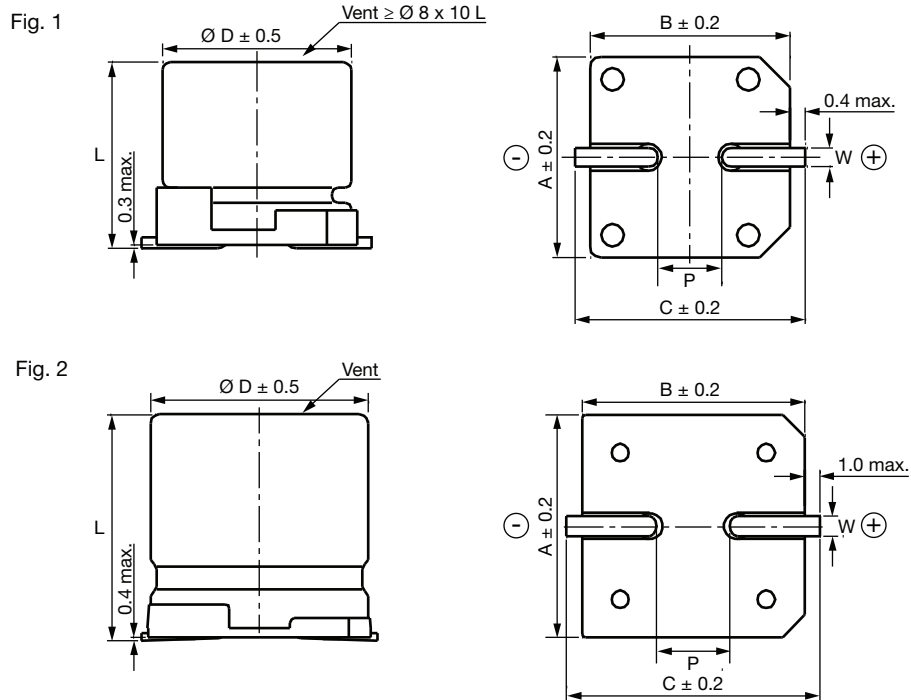
DIMENSIONS in millimeters

CASE SIZE CODE	$\varnothing D$	L	A	B	C	W	P ± 0.2	FIG. NO.
AB	4 x 5.7	4	5.7 ± 0.3	4.3	4.3	5.1	1.0	1
AC	5 x 5.7	5	5.7 ± 0.3	5.3	5.3	5.9	1.5	1
AD	6.3 x 5.7	6.3	5.7 ± 0.3	6.6	6.6	7.2	2.0	1
BM	6.3 x 7.7	6.3	7.7 ± 0.3	6.6	6.6	7.2	2.0	1
AE	8 x 6.5	8	6.5 ± 0.3	8.4	8.4	9.0	2.3	1
AF	8 x 10	8	10 ± 0.5	8.4	8.4	9.0	3.1	1
XM	10 x 7.7	10	7.7 ± 0.3	10.4	10.4	11.0	4.7	1
AG	10 x 10	10	10 ± 0.5	10.4	10.4	11.0	4.7	1
AH	12.5 x 13.5	12.5	13.5 ± 0.5	13.0	13.0	13.7	4.4	2
CX	12.5 x 16	12.5	16 ± 0.5	13.0	13.0	13.7	4.4	2
AK	16 x 16.5	16	16.5 ± 0.5	17.0	17.0	18.0	6.4	2
AM	16 x 21.5	16	21.5 ± 0.5	17.0	17.0	18.0	6.4	2
AN	18 x 16.5	18	16.5 ± 0.5	19.0	19.0	20.0	6.4	2
AP	18 x 21.5	18	21.5 ± 0.5	19.0	19.0	20.0	6.4	2

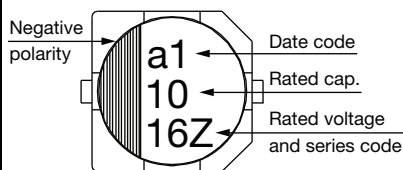
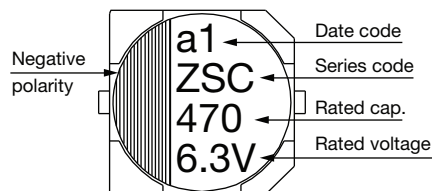
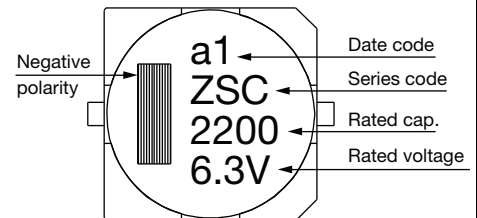
MARKING
 $\varnothing D \leq 6.3 \text{ mm}$

 $\varnothing D = 8 \text{ mm to } 10 \text{ mm}$

 $\varnothing D \geq 12.5 \text{ mm}$

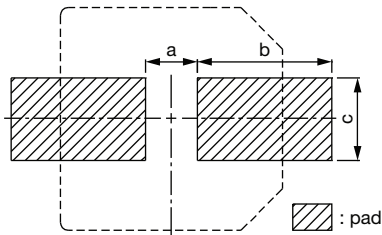

SELECTION CHART, DIMENSIONS, AND PERMISSIBLE RIPPLE CURRENT (at 100 kHz/105 °C)																				
V _{DC}		6.3 (0J)			10 (1A)			16 (1C)			25 (1E)			35 (1V)			50 (1H)			
CAP.	CODE	Ø D x L	IMP.	mA	Ø D x L	IMP.	mA	Ø D x L	IMP.	mA	Ø D x L	IMP.	mA	Ø D x L	IMP.	mA	Ø D x L	IMP.	mA	
1.0	010																4 x 5.7	2.9	60	
2.2	2R2																4 x 5.7	2.9	60	
3.3	3R3																4 x 5.7	2.9	60	
4.7	4R7													4 x 5.7	1.35	80	5 x 5.7	1.52	85	
10	100							4 x 5.7	1.35	80	4 x 5.7	1.35	80	5 x 5.7	0.80	150	6.3 x 5.7	0.88	165	
22	220	4 x 5.7	1.35	80	4 x 5.7	1.35	80	5 x 5.7	0.80	150	5 x 5.7	0.80	150	6.3 x 5.7	0.44	230	6.3 x 5.7	0.88	165	
33	330	4 x 5.7	1.35	80	5 x 5.7	0.80	150	6.3 x 5.7	0.44	230	6.3 x 5.7	0.44	230	6.3 x 5.7	0.44	230	6.3 x 7.7	0.68	185	
47	470	5 x 5.7	0.80	150	6.3 x 5.7	0.44	230	6.3 x 5.7	0.44	230	6.3 x 5.7	0.44	230	6.3 x 5.7	0.44	230	6.3 x 7.7 8 x 6.5	0.68	185	
68	680													8 x 6.5	0.36	280	8 x 10	0.34	369	
100	101	6.3 x 5.7	0.44	230	6.3 x 5.7	0.44	230	6.3 x 5.7	0.44	230	6.3 x 7.7 8 x 6.5	0.36	280	8 x 10	0.17	450	8 x 10 10 x 10	0.34 0.18	369 553	
150	151	6.3 x 5.7	0.44	230	6.3 x 5.7	0.44	230	6.3 x 7.7 8 x 6.5	0.36	280	8 x 10	0.17	450	8 x 10 10 x 7.7	0.17	450	10 x 10	0.18	553	
220	221	6.3 x 7.7	0.36	280	6.3 x 7.7 8 x 6.5	0.36	280	6.3 x 7.7	0.36	280	8 x 10 10 x 7.7	0.17	450	10 x 10	0.09	670	12.5 x 13.5	0.12	650	
330	331	8 x 6.5 8 x 10	0.36 0.17	280 450	8 x 10 10 x 7.7	0.17	450	8 x 10 10 x 7.7	0.17	450	8 x 10	0.17	450	12.5 x 13.5	0.070	820	12.5 x 13.5	0.12	650	
470	471	8 x 10 10 x 7.7	0.17	450	8 x 10 10 x 7.7	0.17	450	8 x 10 10 x 10	0.17 0.09	450 670	10 x 10	0.09	670	12.5 x 16	0.060	950	16 x 16.5	0.073	1000	
680	681	8 x 10 10 x 7.7	0.17	450	10 x 10	0.09	670	10 x 10	0.09	670	12.5 x 13.5	0.070	820	12.5 x 16	0.060	950	16 x 16.5	0.073	1000	
1000	102	8 x 10	0.17	450	10 x 10	0.09	670	12.5 x 13.5	0.070	820	12.5 x 16	0.060	950	16 x 16.5	0.054	1260	18 x 16.5	0.066	1500	
1500	152	10 x 10	0.09	670	12.5 x 13.5	0.070	820	12.5 x 16	0.060	950	16 x 16.5	0.054	1260	18 x 16.5 16 x 21.5	0.048 0.038	1500 1630	18 x 21.5	0.05	1620	
2200	222	12.5 x 13.5	0.070	820	12.5 x 16	0.060	950	16 x 16.5	0.054	1260	16 x 16.5	0.054	1260	18 x 21.5	0.038	1750				
3300	332	12.5 x 16	0.060	950	16 x 16.5	0.054	1260	16 x 16.5 16 x 21.5	0.054 0.038	1260 1630	18 x 16.5 16 x 21.5 18 x 21.5	0.048 0.038 0.038	1500 1630 1750							
4700	472	16 x 16.5	0.054	1260	16 x 16.5	0.054	1260	18 x 16.5 16 x 21.5	0.048 0.038	1500 1630										
6800	682	18 x 16.5 16 x 21.5	0.048 0.038	1500 1630	18 x 16.5 16 x 21.5	0.048 0.038	1500 1630													
8200	822	18 x 16.5 16 x 21.5	0.048 0.038	1500 1630	18 x 21.5	0.038	1750													

SELECTION CHART, DIMENSIONS, AND PERMISSIBLE RIPPLE CURRENT (at 100 kHz/105 °C)										
V _{DC}		63 (1J)			80 (1K)			100 (2A)		
CAP.	CODE	Ø D x L	IMP.	mA	Ø D x L	IMP.	mA	Ø D x L	IMP.	mA
4.7	4R7	5 x 5.7	1.90	70						
10	100	6.3 x 5.7	1.20	130						
22	220	6.3 x 7.7	0.90	150	8 x 10	1.3	130	8 x 10	1.3	130
33	330	8 x 10	0.50	280	8 x 10	1.3	130	10 x 10	0.7	200
47	470	8 x 10	0.50	280	10 x 10	0.7	200	10 x 10	0.7	200
100	101	10 x 10	0.25	450	10 x 10	0.7	200	12.5 x 13.5	0.32	450
150	151	12.5 x 13.5	0.15	700	12.5 x 13.5	0.32	450	12.5 x 16	0.26	550
220	221	12.5 x 13.5	0.15	700	12.5 x 16	0.26	550	16 x 16.5 18 x 21.5	0.17 0.15	650 950
330	331	16 x 16.5	0.082	900	16 x 16.5	0.17	650	18 x 16.5 16 x 21.5	0.15	850 900
470	471	16 x 16.5	0.082	900	18 x 16.5 16 x 21.5	0.15	850 900	18 x 21.5	0.15	950
680	681	18 x 16.5 16 x 21.5	0.080	1150	18 x 21.5	0.15	950			
1000	102	18 x 21.5	0.060	1250						

SOLDERING

Recommended soldering pad dimensions

RECOMMENDED SOLDERING PAD DIMENSIONS in millimeters			
CASE SIZE (\emptyset)	LAND SIZE		
	a	b	c
3	0.8	2.2	1.6
4	1.0	2.6	1.6
5	1.4	3.0	1.6
6.3	1.9	3.5	1.6
8 x 6.5	2.1	4.0	1.6
8	3.0	3.5	2.5
10	4.0	4.0	2.5
12.5	4.0	6.0	3.2
16	6.0	7.0	3.2
18	6.0	8.0	3.2

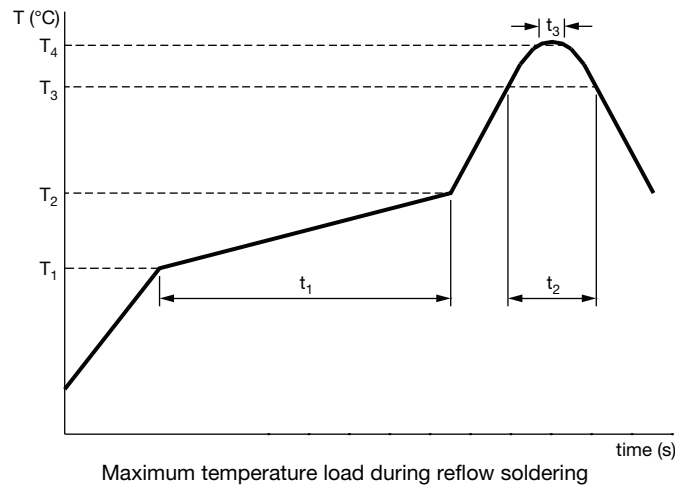
STANDARD SOLDERING PROFILE FOR LEAD (Pb)-FREE REFLOW PROCESS

REFLOW SOLDERING CONDITIONS						
Rated voltage (V)	4 to 50		4 to 50		63 and up	4 and up
Case size (\emptyset)	4 to 6.3 x 4.5 l		3 to 6.3		3 to 6.3	8 to 18
Preheat	Temperature (T_1 to T_2 , °C)	150 to 180				
	Time (t_1) (max., s)	1210	100			
Duration	Temperature (T_3 , °C)	230	217	230	217	217
	Time (t_2) (max., s)	30	90	60	60	40
Peak	Temperature (T_4 , °C)	250	260		250	240
	Time (t_3 , s)	5				
Reflow cycles	1			2 or less		



Disclaimer

ALL PRODUCT, PRODUCT SPECIFICATIONS AND DATA ARE SUBJECT TO CHANGE WITHOUT NOTICE TO IMPROVE RELIABILITY, FUNCTION OR DESIGN OR OTHERWISE.

Vishay Intertechnology, Inc., its affiliates, agents, and employees, and all persons acting on its or their behalf (collectively, "Vishay"), disclaim any and all liability for any errors, inaccuracies or incompleteness contained in any datasheet or in any other disclosure relating to any product.

Vishay makes no warranty, representation or guarantee regarding the suitability of the products for any particular purpose or the continuing production of any product. To the maximum extent permitted by applicable law, Vishay disclaims (i) any and all liability arising out of the application or use of any product, (ii) any and all liability, including without limitation special, consequential or incidental damages, and (iii) any and all implied warranties, including warranties of fitness for particular purpose, non-infringement and merchantability.

Statements regarding the suitability of products for certain types of applications are based on Vishay's knowledge of typical requirements that are often placed on Vishay products in generic applications. Such statements are not binding statements about the suitability of products for a particular application. It is the customer's responsibility to validate that a particular product with the properties described in the product specification is suitable for use in a particular application. Parameters provided in datasheets and/or specifications may vary in different applications and performance may vary over time. All operating parameters, including typical parameters, must be validated for each customer application by the customer's technical experts. Product specifications do not expand or otherwise modify Vishay's terms and conditions of purchase, including but not limited to the warranty expressed therein.

Except as expressly indicated in writing, Vishay products are not designed for use in medical, life-saving, or life-sustaining applications or for any other application in which the failure of the Vishay product could result in personal injury or death. Customers using or selling Vishay products not expressly indicated for use in such applications do so at their own risk. Please contact authorized Vishay personnel to obtain written terms and conditions regarding products designed for such applications.

No license, express or implied, by estoppel or otherwise, to any intellectual property rights is granted by this document or by any conduct of Vishay. Product names and markings noted herein may be trademarks of their respective owners.

Material Category Policy

Vishay Intertechnology, Inc. hereby certifies that all its products that are identified as RoHS-Compliant fulfill the definitions and restrictions defined under Directive 2011/65/EU of The European Parliament and of the Council of June 8, 2011 on the restriction of the use of certain hazardous substances in electrical and electronic equipment (EEE) - recast, unless otherwise specified as non-compliant.

Please note that some Vishay documentation may still make reference to RoHS Directive 2002/95/EC. We confirm that all the products identified as being compliant to Directive 2002/95/EC conform to Directive 2011/65/EU.

Vishay Intertechnology, Inc. hereby certifies that all its products that are identified as Halogen-Free follow Halogen-Free requirements as per JEDEC JS709A standards. Please note that some Vishay documentation may still make reference to the IEC 61249-2-21 definition. We confirm that all the products identified as being compliant to IEC 61249-2-21 conform to JEDEC JS709A standards.